

# Pipe Plugs and Packers

# CONTENTS

## 1.0. Pneumatic pipe plugs

### SMALL DIMENSION PLUGS

1.1.	PLUGS OF SMALLER DIMENSIONS – PLUGY Z AND PLUGSY S	4
1.2.	LONG PLUGS – PLUGY DC	6
1.3.	GAS PLUGS – PLUGY G AND PLUGSY GM	8

### LARGER DIMENSION PLUGS

1.4.	PLUGS OF LARGER DIMENSIONS – PLUGY AND PLUGSY	10
1.5.	HIGH-PERFORMANCE PLUGS – PLUGY HPF AND PLUGSY HPF	12
1.6.	LARGER FLOW PLUGS – PLUGSY VP	14
1.7.	PROTECTION SLEEVES FOR PLUGS	16
1.8.	CHEMICAL-RESISTANT PLUGS MADE FROM CR RUBBER – PLUGY C AND PLUGSY C	17
1.9.	CHEMICAL-RESISTANT PLUGS MADE FROM NBR RUBBER – PLUGY NBR	19
1.10.	CONE-SHAPED PLUGS – PLUGY CP AND PLUGSY CP	21
1.11.	ROUND-SHAPED PLUGS – PLUGSY B-VP	23
1.12.	PILLOW-SHAPED PLUGS – PLUGY PILLOW AND PLUGSY PILLOW	24
1.13.	EGG-SHAPED PLUGS – PLUGY EI, PLUGY EI PILLOW AND PLUGSY EI, PLUGSY EI PILLOW	26
1.14.	MANHOLE PLUGS – PLUGSY VJ	28
1.15.	HIGH-PRESSURE PLUGS – PLUGY HP 6 bar (87 psi), 12 bar (174 psi) AND 30 bar (435 psi)	29
1.16.	TEST ACCESSORIES	31
1.17.	HOUSE CONNECTION TEST SET	34

## 2.0. Pneumatic rehabilitation packers

2.1.	LATERAL PACKERS	37
2.2.	MEDUSA PACKERS	39
2.3.	90° PACKERS	41
2.4.	FLEXIBLE PACKERS	43
2.5.	LONG PACKERS	45
2.6.	SHORT PACKERS	47
2.7.	T PACKERS	48
2.8.	ULTRA FLEX ADVANCED PACKER - UFAP PACKER	49

## 3.0. Table of Resistance

3.0.	TABLE OF RESISTANCE	50
------	---------------------	----

## 4.0. About us

4.1.	WARRANTY	53
4.2.	ABOUT US	54

# Pneumatic pipe plugs

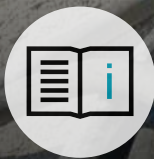

FOLLOW  
USER MANUAL



CLEAN THE PIPE  
BEFORE USE



PROVIDE  
PLUG SUPPORT



WEAR PERSONAL  
PROTECTIVE EQUIPMENT



# PLUGS OF SMALLER DIMENSIONS – PLUGY Z AND PLUGSY S



TR 15

## 1. 1.

SAVA plugs of smaller diameters **PLUGY Z** and **PLUGSY S** can be used in all types of pipelines. Since these plugs are not reinforced with cord, they exhibit excellent stretching and sealing characteristics in pipe diameters from 20 mm (0.8") up to 305 mm (12"). Plugs are equipped with a car tyre inflation valve and can be inflated with a standard tyre pump. An eyebolt with a chain and a specially designed handle simplify manipulation of the plug.



Extra short for easier insertion

Available in usage ranges from 20 mm (0.8") up to 305 mm (12")

Also available in oil-resistant quality

Perfect for plumbers

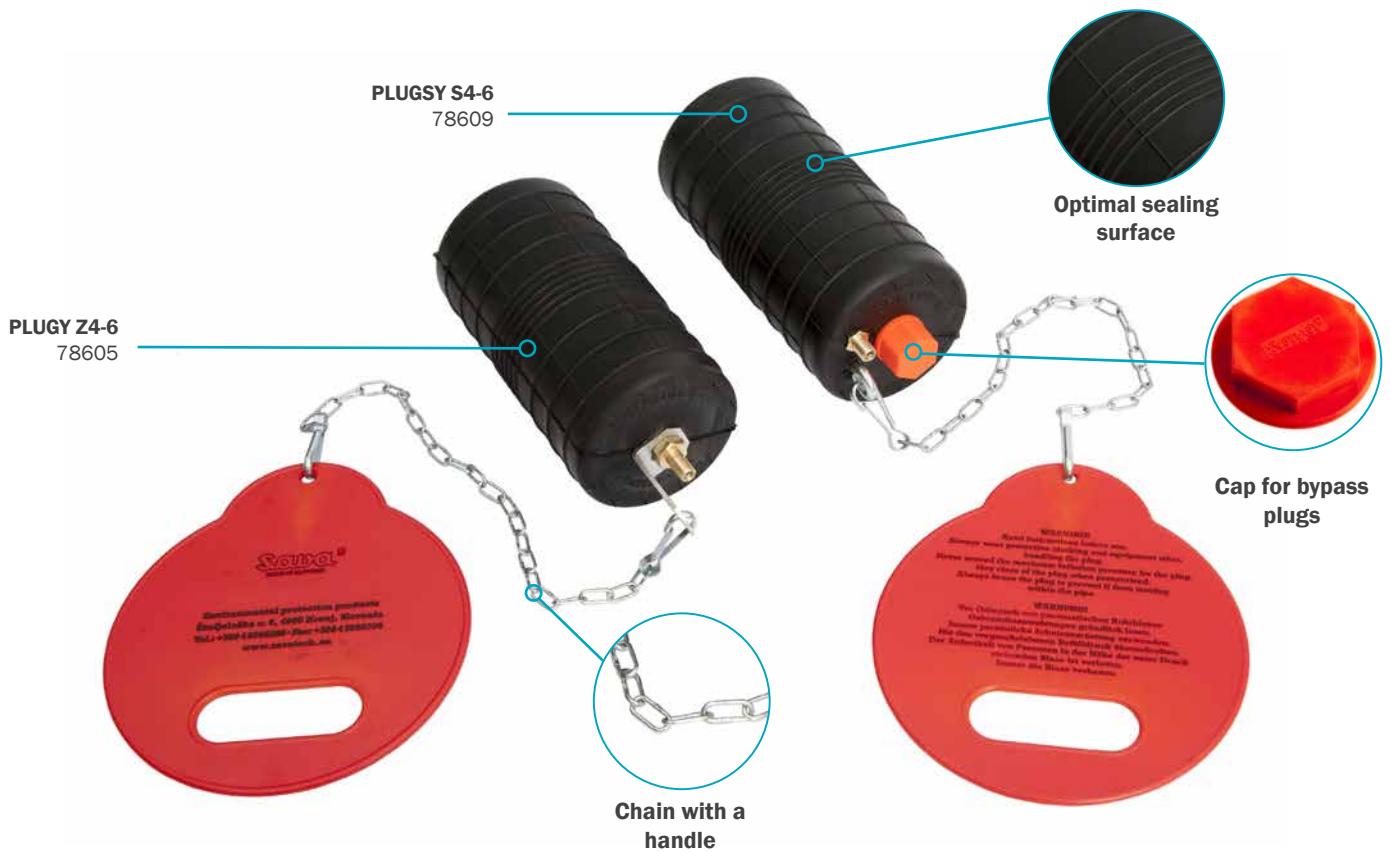

PLUGSY S4-6  
78609

PLUGY Z4-6  
78605

Optimal sealing surface

Cap for bypass plugs

Chain with a handle

## ACCESSORIES



**INFLATION HOSE, FI 6 mm,**  
2 m (6.6'), 0.2 kg (0.44 lbs)  
78904  
5 m (16.4'), 0.5 kg (1.1 lbs)  
78905



**HAND PUMP**  
0.8 kg (1.8 lbs)  
60010



**REPLACEMENT CAPS**  
CAP 1/8" 539897  
CAP 1/2" 539898  
CAP 1" 539899  
CAP 2" 538797  
CAP 4" 539900

# PLUGS OF SMALLER DIMENSIONS – PLUGY Z AND PLUGSY S

1. 1.

## PLUGY Z - BLOCKING PLUGS

PART NUMBER	NOMINAL SIZE	SIZE USAGE RANGE		REQUIRED INFLATION PRESSURE [bar] / [psi]	DEFLATED PLUG		PRODUCT WEIGHT [kg] / [oz / lbs]	EYE BOLT	INFLATION VALVE
		MIN. DIA. [mm] / [inch]	MAX. DIA. [mm] / [inch]		DIAMETER [mm] / [inch]	RUBBER LENGTH [mm] / [inch]			
508123	Z1	20 / 0.75"	33 / 1.3"	2.5 / 36	19 / 0.8"	65 / 2.6"	0.01 / 0.4 oz	NA	R 1/8"
60022	Z1 1/2	33 / 1.3"	40 / 1.6"	2.5 / 36	32 / 1.3"	70 / 2.8"	0.09 / 3.2 oz	NA	R 1/4"
78582	Z2	50 / 2"		2.5 / 36	45 / 1.8"	72 / 2.8"	0.11 / 3.9 oz	NA	R 1/4"
78603	Z2-3	50 / 2"	75 / 3"	2.5 / 36	45 / 1.8"	80 / 3.1"	0.12 / 4.2 oz	NA	R 1/4"
76767	Z3	75 / 3"		2.5 / 36	70 / 2.8"	85 / 3.3"	0.23 / 8.1 oz	NA	R 1/4"
78604	Z3-4	75 / 3"	100 / 4"	2.5 / 36	70 / 2.8"	100 / 3.9"	0.25 / 8.8 oz	NA	R 1/4"
76769	Z4	100 / 4"		2.5 / 36	85 / 3.3"	145 / 5.7"	0.43 / 15 oz	NA	R 1/4"
78605	Z4-6	100 / 4"	150 / 6"	2.5 / 36	85 / 3.3"	165 / 6.5"	0.47 / 1 lbs	NA	R 1/4"
76771	Z6	150 / 6"		2.5 / 36	142 / 5.6"	190 / 7.5"	1.23 / 2.7 lbs	NA	R 1/4"
78606	Z6-8	150 / 6"	200 / 8"	2.5 / 36	142 / 5.6"	220 / 8.7"	1.32 / 2.9 lbs	NA	R 1/4"
60616	Z8	175 / 7"	204 / 8"	2.5 / 36	174 / 6.9"	220 / 8.7"	2.1 / 4.6 lbs	6	R 1/4"
60618	Z10	219 / 9"	254 / 10"	2.5 / 36	218 / 8.6"	250 / 9.8"	3.4 / 7.5 lbs	6	R 1/4"
60619	Z12	275 / 11"	305 / 12"	2.5 / 36	274 / 10.8"	290 / 10.8"	5.1 / 11 lbs	6	R 1/4"

## PLUGSY S - BYPASS PLUGS

PART NUMBER	NOMINAL SIZE	SIZE USAGE RANGE		REQUIRED INFLATION PRESSURE [bar] / [psi]	DEFLATED PLUG		PRODUCT WEIGHT [kg] / [oz / lbs]	EYE BOLT	INFLATION VALVE	BYPASS DIAMETER [FEMALE]
		MIN. DIA. [mm] / [inch]	MAX. DIA. [mm] / [inch]		DIAMETER [mm] / [inch]	RUBBER LENGTH [mm] / [inch]				
78607	S2	50 / 2"		2.5 / 36	45 / 1.8"	80 / 3.1"	0.2 / 7 oz	NA	R 1/8"	1/8"
76768	S3	75 / 3"		2.5 / 36	70 / 2.8"	85 / 3.3"	0.34 / 12 oz	6	R 1/8"	1/2"
78614	S3-4	75 / 3"	100 / 4"	2.5 / 36	70 / 2.8"	100 / 3.9"	0.43 / 15 oz	6	R 1/8"	1/2"
76770	S4	100 / 4"		2.5 / 36	85 / 3.3"	145 / 5.7"	0.6 / 1.3 lbs	6	R 1/8"	1/2"
78609	S4-6	100 / 4"	150 / 6"	2.5 / 36	85 / 3.3"	165 / 6.5"	0.73 / 1.6 lbs	6	R 1/8"	1/2"
76772	S6	150 / 6"		2.5 / 36	142 / 5.6"	190 / 7.5"	2.13 / 4.7 lbs	6	R 1/8"	1"
78610	S6-8	150 / 6"	200 / 8"	2.5 / 36	142 / 5.6"	220 / 8.7"	2.38 / 5 lbs	6	R 1/8"	1"
60621	S8	175 / 7"	204 / 8"	2.5 / 36	174 / 6.9"	240 / 9.5"	3.3 / 7 lbs	6	R 1/4"	2"
60622	S10	219 / 9"	254 / 10"	2.5 / 36	218 / 8.6"	300 / 11.8"	4.7 / 10 lbs	6	R 1/4"	2"
60623	S12	275 / 11"	305 / 12"	2.5 / 36	274 / 10.8"	350 / 13.7"	7.4 / 16 lbs	6	R 1/4"	2"

## BACK PRESSURES [BAR] / [psi]\* - PLUGY Z, PLUGSY S

PLUG SIZE	PIPE DIAMETER [mm] / [inch]								
	25 / 1"	40 / 1.6"	50 / 2"	75 / 3"	100 / 4"	150 / 6"	200 / 8"	250 / 10"	300 / 12"
1"	2.2 / 32								
1 1/2"		2.2 / 32							
2"			1.8 / 26						
2"- 3"			2 / 29	1.5 / 22					
3"				1.5 / 22					
3"- 4"				1.8 / 26	1.2 / 17				
4"					1.9 / 28				
4"- 6"					1.9 / 28	1.6 / 23			
6"						2.2 / 32			
6"- 8"						2.2 / 32	1.4 / 20		
8"							1.3 / 19		
10"								1.5 / 22	
12"									1.8 / 26

\* measured in a dry iron pipe

## 1. 2.

## LONG PLUGS – PLUGY DC



TR 15

The construction of SAVA multi-size long plugs **PLUGY DC** ensures efficient sealing of both connection and the main pipe at the same time. **SAVA PLUGY DC** are equipped with a 100 cm (39.4") long supply hose.



Special inflation sequence

Sealing of main and lateral pipes simultaneously

Equipped with inflation hose

**PLUGY DC 75-100 (3"-4")**  
60074



Start of inflation process

### ACCESSORIES



**INFLATION HOSE, FI 6 mm,**  
2 m (6.6'),  
0.2 kg (0.44 lbs)  
78904



**INFLATION HOSE FI 6 mm,**  
5 m (16.4'),  
0.5 kg (1.1 lbs)  
78905



**HAND PUMP, 0.8 kg**  
(1.8 lbs)  
60010

## HANDLING

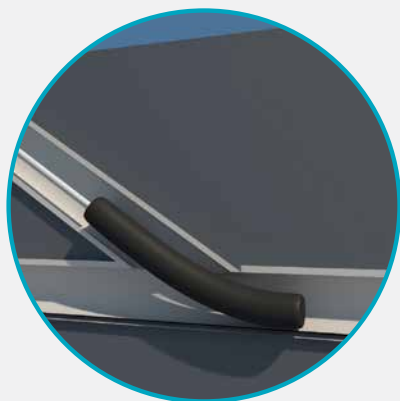

INSERT THE PLUG IN THE MIDDLE OF A CONNECTION

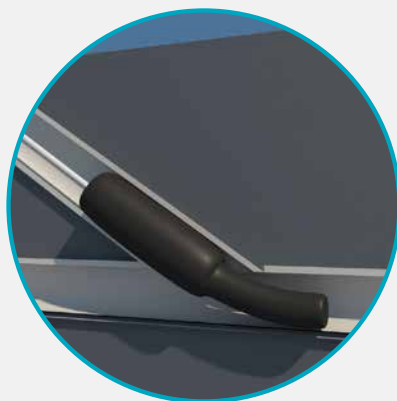

IN THE FIRST PHASE, THE UPPER PLUG PART IS INFLATED TO PREVENT LIQUID SPILLS

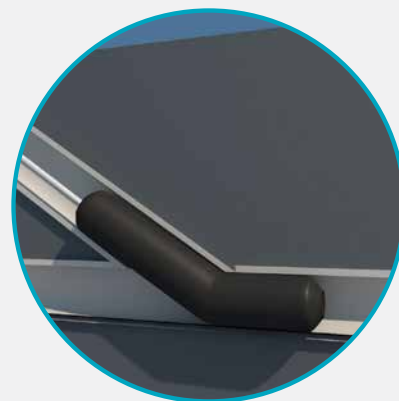

IN THE SECOND PHASE, THE REMAINING PART OF THE PLUG IS INFLATED TO COMPLETELY STOP THE FLOW

### PLUGY DC - BLOCKING PLUGS

PART NUMBER	NOMINAL SIZE	SIZE USAGE RANGE		REQUIRED INFLATION PRESSURE [bar] / [psi]	DEFLATED PLUG		PRODUCT LENGHT [mm] / [inch]	PRODUCT WEIGHT [kg] / [lbs]	EYE BOLT M THREAD	INFLATION VALVE THREAD SIZE
		MIN. DIA. [mm] / [inch]	MAX. DIA. [mm] / [inch]		DIAMETER [mm] / [inch]	RUBBER LENGTH [mm] / [inch]				
60073	50-75 / 2"-3"	50 / 2"	75 / 3"	2.5 / 36	40 / 1.6"	490 / 19"	550 / 22"	0.7 / 1.5	NA	TR 15
60074	75-100 / 3"-4"	75 / 3"	100 / 4"	2.5 / 36	60 / 2.4"	550 / 22"	610 / 24"	1.2 / 3	NA	TR 15
60075	100-150 / 4"-6"	100 / 4"	150 / 6"	2.5 / 36	80 / 3.1"	750 / 30"	810 / 32"	1.8 / 4	NA	TR 15
60076	150 / 6"	150 / 6"	150 / 6"	2.5 / 36	100 / 3.9"	730 / 29"	790 / 31"	2.6 / 6	NA	TR 15

### BACK PRESSURES [BAR] / [psi]\* - PLUGY DC

PLUG SIZE	PIPE DIAMETER [mm] / [inch]			
	50 / 2"	75 / 3"	100 / 4"	150 / 6"
50-75 / 2"-3"	2.2 / 32	2 / 39		
75-100 / 3"-4"		2.1 / 30	1.9 / 28	
100-150 / 4"-6"			2 / 29	1.8 / 26
150 / 6"				1.9 / 28

\* measured in a dry iron pipe



# 1. 3.

# GAS PLUGS – PLUGY G AND PLUGSY GM



SAVA multi-size plugs **PLUGY G** and **PLUGSY GM** are used for sealing and testing of pipelines and gas pipelines with a restricted inlet area. Their innovative design and flexibility simplify handling and insertion.



Special elliptical shape

Very small insertion diameter required

Highly flexible

Also available in oil-resistant version

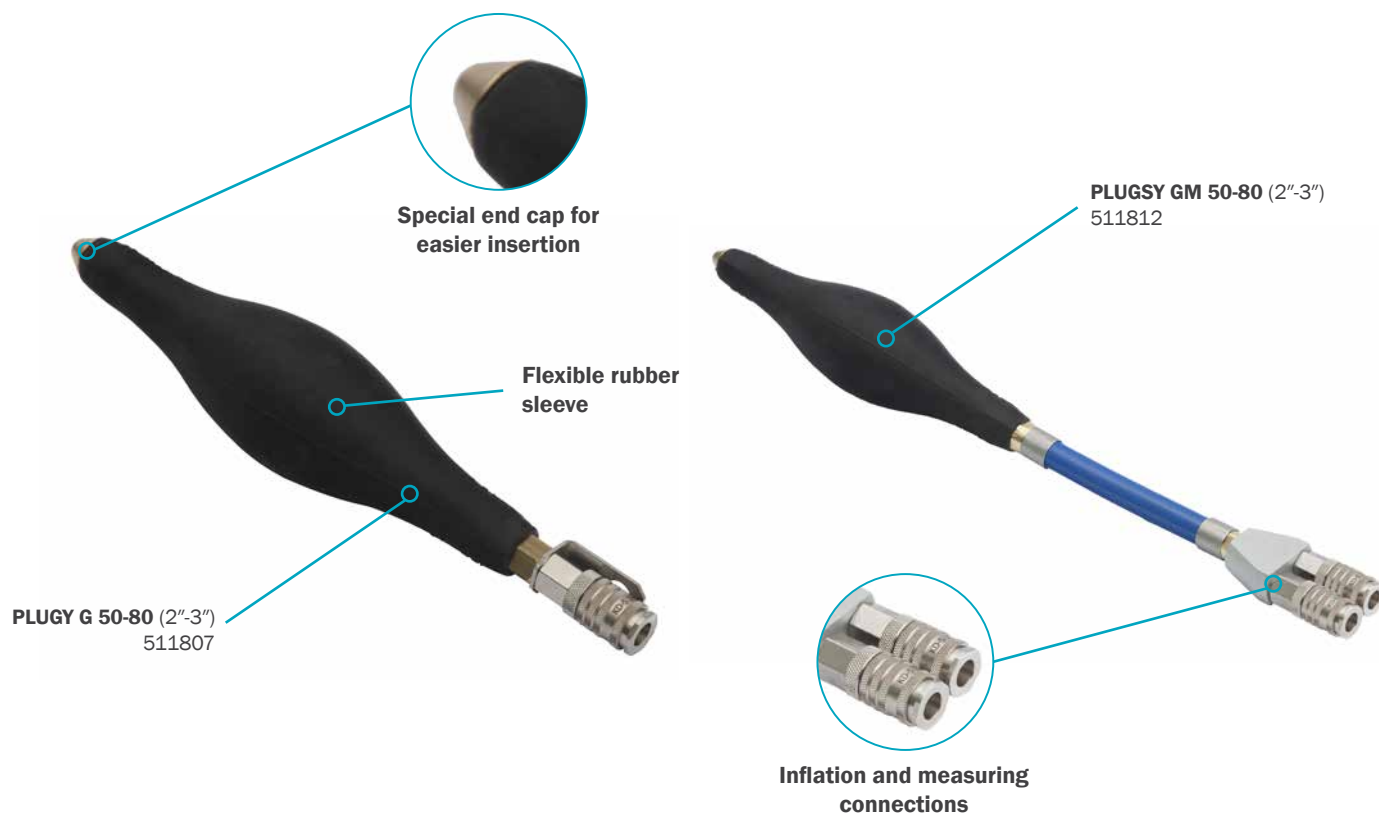

## ACCESSORIES



**INFLATION HOSE,**  
10 m (33'), **RED**  
1.2 kg (2.6 lbs)  
74268



**INFLATION HOSE,**  
10 m (33'), **BLUE**  
1.2 kg (2.6 lbs)  
71248



**INFLATION HOSE,**  
10 m (33'), **YELLOW**  
1.2 kg (2.6 lbs)  
76686



## ACCESSORIES



**SINGLE FITTING CONTROLLER,**  
**2.5 bar (36 psi),**  
**0.9 kg (2 lbs)**  
 60310

**SINGLE FITTING CONTROLLER,**  
**3.0 bar (44psi),**  
**0.9 kg (2 lbs)**  
 537048

**SINGLE FITTING CONTROLLER,**  
**1.5 bar (22 psi),**  
**0.9 kg (2 lbs)**  
 74609

**SINGLE FITTING CONTROLLER,**  
**2.0 bar (29 psi),**  
**0.9 kg (2 lbs)**  
 565643



**POLY LIFT INFLATION HOSE,**  
**5 m (16.4'), 1.9 kg (4.2 lbs)**  
 60957

**POLY LIFT INFLATION HOSE,**  
**10 m (33'), 2.4 kg (5.3 lbs)**  
 60958

### PLUGY G - BLOCKING PLUGS

PART NUMBER	NOMINAL SIZE	SIZE USAGE RANGE		REQUIRED INFLATION PRESSURE [bar] / [psi]	MAX. ALLOWED BACK PRESSURE [bar] / [psi]	DEFLATED PLUG		DIAMETER FOR INSERTION [mm] / [inch]	PRODUCT WEIGHT [kg] / [lbs]	INFLATION VALVE THREAD SIZE
		MIN. DIA. [mm] / [inch]	MAX. DIA. [mm] / [inch]			DIAMETER [mm] / [inch]	LENGTH [mm] / [inch]			
511807	50-80 / 2"-3"	50 / 2"	80 / 3"	3 / 44	1 / 15	45 / 1.8"	280 / 11"	35 / 1.4"	0.29 / 0.6	R 1/4"
511808	80-130 / 3"-5"	80 / 3"	130 / 5"	2.5 / 36	1 / 15	76 / 3"	360 / 14"	40 / 1.6"	0.37 / 0.8	R 1/4"
511809	100-160 / 4"-6"	100 / 4"	160 / 6"	2 / 29	1 / 15	98 / 3.9"	420 / 17"	45 / 1.8"	0.56 / 1.2	R 3/8"
511810	150-210 / 6"-8"	145 / 6"	210 / 8"	2 / 29	1 / 15	140 / 5.5"	510 / 20"	50 / 2"	0.78 / 1.7	R 3/8"
511811	200-315 / 8"-12"	200 / 8"	315 / 12"	2 / 29	1 / 15	200 / 7.9"	730 / 29"	70 / 2.8"	1.25 / 2.8	R 3/8"
519420	315-500 / 12"-20"	315 / 12"	500 / 20"	1.5 / 22	0.8 / 12	315 / 12.4"	950 / 37"	90 / 3.5"	1.45 / 3.2	R 3/8"

### PLUGSY GM - BYPASS PLUGS

PART NUMBER	NOMINAL SIZE	SIZE USAGE RANGE		REQUIRED INFLATION PRESSURE [bar] / [psi]	MAX. ALLOWED BACK PRESSURE [bar] / [psi]	DEFLATED PLUG		DIAMETER FOR INSERTION [mm] / [inch]	PRODUCT WEIGHT [kg] / [lbs]	INFLATION VALVE THREAD SIZE	BYPASS DIAMETER
		MIN. DIA. [mm] / [inch]	MAX. DIA. [mm] / [inch]			DIAMETER [mm] / [inch]	LENGTH [mm] / [inch]				
511812	50-80 / 2"-3"	45 / 1.8"	80 / 3"	3 / 44	1 / 15	45 / 1.8"	490 / 19"	35 / 1.4"	0.71 / 1.6	R 1/4"	5
511813	80-130 / 3"-5"	75 / 3"	130 / 5"	2.5 / 36	1 / 15	76 / 3"	570 / 22"	40 / 1.6"	0.79 / 1.7	R 1/4"	5
511814	100-160 / 4"-6"	100 / 3.9"	160 / 6"	2 / 29	1 / 15	98 / 3.9"	645 / 25"	45 / 1.8"	1.01 / 2.2	R 3/8"	7
511815	150-210 / 6"-8"	145 / 5.7"	210 / 8"	2 / 29	1 / 15	140 / 5.5"	760 / 30"	50 / 2"	1.22 / 2.7	R 3/8"	7
511816	200-315 / 8"-12"	200 / 7.9"	315 / 12"	2 / 29	1 / 15	200 / 7.9"	1060 / 42"	70 / 2.8"	1.72 / 3.8	R 3/8"	7
519421	315-500 / 12"-20"	315 / 12.4"	500 / 20"	1.5 / 22	0.8 / 12	315 / 12.4"	1280 / 50"	90 / 3.5"	1.9 / 4.2	R 3/8"	7

# PLUGS OF LARGER DIMENSIONS – PLUGY AND PLUGSY



## 1. 4.

SAVA multi-size pipe plugs **PLUGY** and **PLUGSY** are reinforced with aramid cord and are noted for a wide application range. Each plug covers several pipe sizes. Multi-size ranges overlap to meet specific requirements. They can cover pipe diameters from 40 mm (1.5") to 1800 mm (72"). Plugs are flexible and bend easily around tight corners or when inserted through the manholes.



**Aramid reinforcement**

**Flexible construction**

**Suitable for EN 1610 tightness test**

**Oil-resistant version available**

**PLUGY 350-600**  
(14"-24")  
60422



**PLUGSY 350-600**  
(14"-24")  
60440



**PLUGY 600-1200**  
(24"-48")  
523941



**PLUGSY 600-1200**  
(24"-48")  
523942



### ACCESSORIES



**SINGLE FITTING CONTROLLER,**  
**0.9 kg (2 lbs)**  
**3.0 bar (44 psi)**  
537048  
**2.5 bar (36 psi)**  
60310  
**1.5 bar (22 psi)**  
74609  
**1.0 bar (15 psi)**  
74653



**HAND HELD SINGLE DEADMAN**  
**2.5 bar (36 psi),**  
**0.9 kg (2 lbs)**  
519442



**INFLATION HOSE,**  
**10 m (33'),**  
**RED**  
**1.2 kg (2.6 lbs)**  
74268



**INFLATION HOSE,**  
**10 m (33'),**  
**BLUE**  
**1.2 kg (2.6 lbs)**  
71248



**INFLATION HOSE,**  
**10 m (33'),**  
**YELLOW**  
**1.2 kg (2.6 lbs)**  
76686



**POLY LIFT INFLATION HOSE,**  
**5 m (16.4'),**  
**1.9 kg (4.2 lbs)**  
60957



**REMOTE PLACEMENT FOR:**  
**PLUGY 100-200**  
**0.8 kg (3.3 lbs)**  
503403  
**PLUGY 200-400**  
**1 kg (2.2 lbs)**  
503404  
**PLUGY 350-600,**  
**500-1000**  
**1.5 kg (3.3 lbs)**  
503406



**TELESCOPIC 3-PART ALU POLE**  
**1 kg (2.2 lbs)**  
529039

# PLUGS OF LARGER DIMENSIONS – PLUGY AND PLUGSY

## 1. 4.

### PLUGY - BLOCKING PLUGS

PART NUMBER	NOMINAL SIZE	SIZE USAGE RANGE		REQUIRED INFLATION PRESSURE [bar] / [psi]	DEFLATED PLUG		PRODUCT WEIGHT [kg] / [lbs]	EYE BOLT M THREAD	INFLATION VALVE THREAD SIZE
		MIN. DIA. [mm] / [inch]	MAX. DIA. [mm] / [inch]		DIAMETER [mm] / [inch]	RUBBER LENGTH [mm] / [inch]			
519423	40-70 / 1.5"-2.8"	40 / 1.5"	70 / 2.8"	2.5 / 36	35 / 1.4"	160 / 6.3"	0.2 / 0.4	NA	R 1/4"
519424	70-150 / 2.8"-6"	70 / 2.8"	150 / 6"	2.5 / 36	68 / 2.7"	300 / 12"	0.4 / 0.9	NA	R 1/4"
60417	100-200 / 4"-8"	100 / 4"	200 / 8"	2.5 / 36	92 / 3.6"	500 / 20"	1.35 / 3	M6	R 1/4"
526850	150-200 / 6"-8"	150 / 6"	200 / 8"	2.5 / 36	142 / 5.6"	350 / 14"	1.85 / 4	M8	R 1/4"
60418	150-300 / 6"-12"	150 / 6"	300 / 12"	2.5 / 36	142 / 5.6"	540 / 21"	2.6 / 6	M8	R 1/4"
60419	200-400 / 8"-16"	200 / 8"	400 / 16"	2.5 / 36	192 / 7.6"	600 / 24"	3.6 / 8	M8	R 1/4"
598515	200-500 / 8"-20"	200 / 8"	500 / 20"	2.5 / 36	192 / 7.6"	600 / 24"	4.5 / 10	M8	R 1/4"
60599	300-525 / 12"-21"	300 / 12"	525 / 21"	2.5 / 36	272 / 10.7"	630 / 25"	6.8 / 15	M8	R 1/4"
598519	300-600 / 12"-24"	300 / 12"	600 / 24"	2.5 / 36	272 / 10.7"	630 / 25"	7.5 / 17	M8	R 1/4"
60422	350-600 / 14"-24"	350 / 14"	600 / 24"	2.5 / 36	322 / 12.7"	830 / 33"	9.8 / 22	M10	R 1/4"
60606	375-750 / 15"-30"	375 / 15"	750 / 30"	2.5 / 36	342 / 13.5"	1050 / 41"	11.9 / 26	M10	R 1/4"
60453	500-800 / 20"-32"	500 / 20"	800 / 32"	2.5 / 36	472 / 18.6"	1150 / 45"	19.5 / 43	M10	R 1/4"
60425	500-1000 / 20"-40"	500 / 20"	1000 / 40"	1.5 / 22	472 / 18.6"	1150 / 45"	19.5 / 43	M10	R 1/4"
523941	600-1200 / 24"-48"	600 / 24"	1200 / 48"	1.5 / 22	574 / 22.6"	1450 / 57"	38 / 84	M10	2 × R 3/8"
78959	750-1500 / 30"-60"	750 / 30"	1500 / 60"	1 / 15	600 / 23.6"	2300 / 91"	75 / 165	M10	2 × R 1/4"
535881	800-1800 / 32"-72"	800 / 32"	1800 / 72"	1 / 15	600 / 23.6"	3000 / 118"	106 / 234	M10	2 × R 1/4"

### PLUGSY - BYPASS PLUGS

PART NUMBER	NOMINAL SIZE	SIZE USAGE RANGE		REQUIRED INFLATION PRESSURE [bar] / [psi]	DEFLATED PLUG		PRODUCT WEIGHT [kg] / [lbs]	EYE BOLT M THREAD	INFLATION VALVE THREAD SIZE	BYPASS DIAMETER (FEMALE)
		MIN. DIA. [mm] / [inch]	MAX. DIA. [mm] / [inch]		DIAMETER [mm] / [inch]	RUBBER LENGTH [mm] / [inch]				
526849	70-150 / 2.8"-6"	70 / 2.8"	150 / 6"	2.5 / 36	68 / 2.7"	300 / 12"	1.7 / 3.7	NA	R 1/4"	1/2"
60429	100-200 / 4"-8"	100 / 4"	200 / 8"	2.5 / 36	92 / 3.6"	500 / 20"	2.7 / 6	M6	R 1/4"	1"
526851	150-200 / 6"-8"	150 / 6"	200 / 8"	2.5 / 36	142 / 5.6"	350 / 14"	3.3 / 7	M8	R 1/4"	1"
60432	150-300 / 6"-12"	150 / 6"	300 / 12"	2.5 / 36	142 / 5.6"	540 / 21"	4.3 / 10	M8	R 1/4"	1"
60434	200-400 / 8"-16"	200 / 8"	400 / 16"	2.5 / 36	192 / 7.6"	600 / 24"	7 / 15	M8	R 1/4"	2"
60630	300-525 / 12"-21"	300 / 12"	525 / 21"	2.5 / 36	272 / 10.7"	630 / 25"	12 / 27	M8	R 1/4"	2"
60440	350-600 / 14"-24"	350 / 14"	600 / 24"	2.5 / 36	322 / 12.7"	830 / 33"	16 / 35	M10	R 1/4"	2"
60632	375-750 / 15"-30"	375 / 15"	750 / 30"	2.5 / 36	342 / 13.5"	1050 / 41"	19.7 / 43	M10	R 1/4"	2"
60454	500-800 / 20"-32"	500 / 20"	800 / 32"	2.5 / 36	472 / 18.6"	1150 / 45"	32.5 / 72	M10	R 1/4"	2"
60442	500-1000 / 20"-40"	500 / 20"	1000 / 40"	1.5 / 22	472 / 18.6"	1150 / 45"	32.5 / 72	M10	R 1/4"	2"
523942	600-1200 / 24"-48"	600 / 24"	1200 / 48"	1.5 / 22	574 / 22.6"	1450 / 57"	55.5 / 122	M10	2 × R 3/8"	4"
78960	750-1500 / 30"-60"	750 / 30"	1500 / 60"	1 / 15	600 / 23.6"	2300 / 91"	91 / 201	M10	2 × R 1/2"	4"
535882	800-1800 / 32"-72"	800 / 32"	1800 / 72"	1 / 15	600 / 23.6"	3000 / 118"	117 / 258	M10	2 × R 1/2"	4"

### BACK PRESSURES [bar] / [psi]\* - PLUGY, PLUGSY

PLUG SIZE	PIPE DIAMETER [mm] / [inch]																				
	40 / 1.5"	70 / 2.8"	100 / 4"	150 / 6"	200 / 8"	250 / 10"	300 / 12"	350 / 14"	400 / 16"	500 / 20"	600 / 24"	800 / 32"	1000 / 40"	1200 / 48"	1300 / 52"	1400 / 56"	1500 / 60"	1600 / 64"	1700 / 68"	1800 / 72"	
40-70 / 1.5"-2.8"	2.0/29	1.2/17																			
70-150 / 2.8"-6"		2.2/32	1.7/25	1.3/19																	
100-200 / 4"-8"			2.2/32	1.7/25	1.3/19																
150-200 / 6"-8"				2.0/29	1.5/22																
150-300 / 6"-12"				2.2/32	2.0/29	1.4/20	1.2/17														
200-400 / 8"-16"					2.2/32	2.0/29	1.7/25	1.5/22	1.2/17												
200-500 / 8"-20"						2.3/33	2.2/32	2.1/30	1.7/25	1.5/22	0.7/10										
300-525 / 12"-21"								2.0/29	1.7/25	1.5/22	1.2/17										
300-600 / 12"-24"									2.2/32	2.0/29	1.7/25	1.2/17	0.4/6								
350-600 / 14"-24"										2.1/30	1.9/28	1.6/23	1.3/19								
375-750 / 15"-30"										2.0/29	1.7/25	1.4/20									
500-800 / 20"-32"											1.8/26	1.4/20	1.1/16								
500-1000 / 20"-40"											1.0/15	0.8/12	0.6/9	0.5/7							
600-1200 / 24"-48"												1.0/15	0.7/10	0.6/9	0.5/7						
750-1500 / 30"-60"													1.0/15	0.9/13	0.8/12	0.7/10	0.6/9	0.5/7			
800-1800 / 32"-72"														1.0/15	1.0/15	0.9/13	0.8/12	0.7/10	0.6/9	0.5/7	0.4/6

\* measured in a dry iron pipe



# 1. 5.

## HIGH-PERFORMANCE PLUGS – PLUGY HPF AND PLUGSY HPF



TYPE 27

SAVA high-performance plugs **PLUGY HPF** and **PLUGSY HPF** made from high-quality rubber mixture and additional built-in aramid reinforcement ensure reliable functioning in more demanding conditions. The family of these plugs is ideal for flow stopping and pipe tightness testing. A wide range of bypass flows (4", 6", 8") is also available. They can withstand higher back pressures.



**Higher back-pressures**

**Extra strong aramid reinforcement**

**Oil-resistant version available**

**A wider range of bypass flows available**



**Heavy duty eyebolts and quick coupling**



**PLUGY HPF 750-1500 (30"-60")**  
545467

### ACCESSORIES



**INFLATION HOSE HPF NW10, 10 m (33'), BLUE (UP TO 500-1000) (TYPE 27)**  
3.4 kg (7.5 lbs)  
547714



**INFLATION HOSE HPF NW12, 10 m (33'), BLUE (FROM 600-1200) (TYPE 57)**  
3.4 kg (7.5 lbs)  
547715



**SINGLE FITTING CONTROLLER, 0.9 kg (2 lbs)**  
3.0 bar (44 psi) (TYPE 27)  
547645



**SINGLE FITTING CONTROLLER, 0.9 kg (2 lbs)**  
2.5 bar (36 psi) (TYPE 57)  
547646  
1.5 bar (22 psi) (TYPE 57)  
547647  
1.0 bar (15 psi) (TYPE 57)  
547650



TYPE 57

# HIGH-PERFORMANCE PLUGS – PLUGY HPF AND PLUGSY HPF

1. 5.

## PLUGY HPF - BLOCKING PLUGS

PART NUMBER	NOMINAL SIZE	SIZE USAGE RANGE		REQUIRED INFLATION PRESSURE [bar] / [psi]	DEFLATED PLUG		PRODUCT WEIGHT [kg] / [lbs]	EYE BOLT M THREAD	INFLATION VALVE THREAD SIZE
		MIN. DIA. [mm] / [inch]	MAX. DIA. [mm] / [inch]		DIAMETER [mm] / [inch]	RUBBER LENGTH [mm] / [inch]			
545456	100-200 / 4"-8"	100 / 4"	200 / 8"	3 / 44	92 / 3.6"	500 / 20"	1.2 / 2.6	M6	R 1/4"
545457	150-300 / 6"-12"	150 / 6"	300 / 12"	3 / 44	142 / 5.6"	540 / 21"	2.3 / 5	M12	R 1/2"
545458	200-400 / 8"-16"	200 / 8"	400 / 16"	3 / 44	192 / 7.6"	600 / 24"	3.8 / 8	M12	R 1/2"
545460	350-600 / 14"-24"	350 / 14"	600 / 24"	3 / 44	322 / 12.7"	830 / 33"	8.9 / 20	M12	R 1/2"
545463	500-800 / 20"-32"	500 / 20"	800 / 32"	3 / 44	472 / 18.6"	1150 / 45"	23 / 51	M12	R 1/2"
545464	500-1000 / 20"-40"	500 / 20"	1000 / 40"	3 / 44	472 / 18.6"	1150 / 45"	23 / 51	M12	R 1/2"
545465	600-1200 / 24"-48"	600 / 24"	1200 / 48"	2.5 / 36	574 / 22.6"	1500 / 59"	39.1 / 86	M16	R 1/2"
545467	750-1500 / 30"-60"	750 / 30"	1500 / 60"	1.5 / 22	600 / 23.6"	2300 / 91"	78.7 / 172	M16	R 1/2"
545783	800-1800 / 32"-72"	800 / 32"	1800 / 72"	1.5 / 22	600 / 23.6"	3000 / 118"	105.1 / 232	M16	R 1/2"
545785	1000-2400 / 40"-96"	1000 / 40"	2400 / 96"	1 / 15	960 / 37.8"	4000 / 158"	313.7 / 692	M16	R 1/2"

## PLUGSY HPF - BYPASS PLUGS

PART NUMBER	NOMINAL SIZE	SIZE USAGE RANGE		REQUIRED INFLATION PRESSURE [bar] / [psi]	DEFLATED PLUG		PRODUCT WEIGHT [kg] / [lbs]	EYE BOLT M THREAD	INFLATION VALVE THREAD SIZE	BYPASS DIAMETER
		MIN. DIA. [mm] / [inch]	MAX. DIA. [mm] / [inch]		DIAMETER [mm] / [inch]	RUBBER LENGTH [mm] / [inch]				
545468	100-200 / 4"-8"	100 / 4"	200 / 8"	3 / 44	92 / 3.6"	500 / 20"	2.6 / 5.7	M6	R 1/4"	1"
545469	150-300 / 6"-12"	150 / 6"	300 / 12"	3 / 44	142 / 5.6"	540 / 21"	3.9 / 9	M8	R 1/4"	1"
545470	200-400 / 8"-16"	200 / 8"	400 / 16"	3 / 44	192 / 7.6"	600 / 24"	6.8 / 15	M12	R 3/8"	2"
545472	350-600 / 14"-24"	350 / 14"	600 / 24"	3 / 44	322 / 12.7"	830 / 33"	14.8 / 33	M12	R 3/8"	2"
545473	500-800 / 20"-32"	500 / 20"	800 / 32"	3 / 44	472 / 18.6"	1150 / 45"	31 / 68	M12	R 3/8"	2"
545474	500-1000 / 20"-40"	500 / 20"	1000 / 40"	3 / 44	472 / 18.6"	1150 / 45"	31 / 68	M12	R 3/8"	2"
545475 *	600-1200 / 24"-48"	600 / 24"	1200 / 48"	2.5 / 36	574 / 22.6"	1500 / 59"	54.3 / 120	M16	R 1/2"	4"/6"/8" *
545476 *	750-1500 / 30"-60"	750 / 30"	1500 / 60"	1.5 / 22	600 / 23.6"	2300 / 91"	94.8 / 209	M16	R 1/2"	4"/6"/8" *
545784 *	800-1800 / 32"-72"	800 / 32"	1800 / 72"	1.5 / 22	600 / 23.6"	3000 / 118"	125.6 / 277	M16	R 1/2"	4"/6"/8" *
545787 *	1000-2400 / 40"-96"	1000 / 40"	2400 / 96"	1 / 15	960 / 37.8"	4000 / 158"	341 / 752	M16	R 1/2"	4"/6"/8" *

\* Note: The Part numbers apply to 4" plugs

## BACK PRESSURES [BAR] / [psi]\* - PLUGY HPF, PLUGSY HPF

PLUG SIZE	PIPE DIAMETER [mm] / [inch]																					
	100 / 4"	150 / 6"	200 / 8"	250 / 10"	300 / 12"	350 / 14"	400 / 16"	500 / 20"	600 / 24"	800 / 32"	1000 / 40"	1200 / 48"	1300 / 52"	1400 / 56"	1500 / 60"	1600 / 64"	1700 / 68"	1800 / 72"	2000 / 80"	2200 / 88"	2400 / 96"	
100-200 3 bar / 4"-8" 44 psi	2.6/38	2.1/30	1.7/25																			
150-300 3 bar / 6"-12" 44 psi		2.6/38	2.4/35	1.8/26	1.6/23																	
200-400 3 bar / 8"-16" 44 psi			2.6/38	2.4/35	2.1/30	1.9/28	1.6/23															
350-600 3 bar / 14"-24" 44 psi					2.6/38	2.5/36	2.0/29	1.7/25														
500-800 3 bar / 20"-32" 44 psi							2.6/38	2.5/36	1.7/25													
500-1000 3 bar / 20"-40" 44 psi							2.6/38	2.5/36	1.7/25	1.0/15												
600-1200 2.5 bar / 24"-48" 36 psi								2.1/30	1.9/28	1.5/22	1.0/15											
750-1500 1.5 bar / 30"-60" 22 psi										1.2/17	1.1/16	1.0/15	0.9/13	0.8/12	0.7/10							
800-1800 1.5 bar / 32"-72" 22 psi										1.3/19	1.2/17	1.1/16	1.0/15	0.9/13	0.8/12	0.7/10	0.6/9	0.5/7				
1000-2400 1.0 bar / 40"-96" 15 psi											0.9/13	0.9/13	0.9/13	0.9/13	0.8/12	0.8/12	0.7/10	0.7/10	0.6/9	0.5/7	0.5/7	0.5/7

\* measured in a dry iron pipe

# 1. 6.

# LARGER FLOW PLUGS – PLUGSY VP



SAVA multi-size plugs with a larger bypass PLUGSY VP cover the ranges from 100 mm (4") up to 1800 mm (72"). A replaceable rubber sleeve is reinforced with aramid cord and ensures safe and simple handling. Plugs are available in three different designs, depending on the conditions and bypass requirements.



Bypass diameter up to 8 inches

Replaceable rubber sleeve and bypass flange

Non-corrodive metal parts



VP2  
PLUGSY VP 200-400 4"  
60968



VP2  
BYPASS ADAPTER  
R2" FOR PLUGSY 200-400  
(8"-16")  
520344

## ACCESSORIES



**SINGLE FITTING CONTROLLER,**  
0.9 kg (2 lbs)  
2.5 bar (36 psi) 60310  
2.0 bar (29 psi) 565643  
1.5 bar (22 psi) 74609  
1.0 bar (15 psi) 74653



**INFLATION HOSE,**  
10 m (33'), RED  
1.2 kg (2.6 lbs)  
74268



**INFLATION HOSE,**  
10 m (33'), BLUE  
1.2 kg (2.6 lbs)  
71248



**INFLATION HOSE,**  
10 m (33'), YELLOW  
1.2 kg (2.6 lbs)  
76686



**POLY LIFT INFLATION HOSE,** 5 m (16.4'), 1.9 kg (4.2 lbs) 60957



**POLY LIFT INFLATION HOSE,** 10 m (33'), 2.4 kg (5.3 lbs) 60958



# LARGER FLOW PLUGS – PLUGSY VP

# 1. 6.

## PLUGSY VP - BYPASS PLUG

PART NUMBER	NOMINAL SIZE	SIZE USAGE RANGE		REQUIRED INFLATION PRESSURE [bar] / [psi]	DEFLATED PLUG		PRODUCT WEIGHT [kg] / [lbs]	EYE BOLT M THREAD	INFLATION VALVE THREAD SIZE	BYPASS DIAMETER (FEMALE)
		MIN. DIA. [mm] / [inch]	MAX. DIA. [mm] / [inch]		DIAMETER [mm] / [inch]	RUBBER LENGTH [mm] / [inch]				
516942	100-150 / 4"-6"	98 / 4"	150 / 6"	2.5 / 36	88 / 3.5"	370 / 15"	2.2 / 5	M 6	Not removable	2"
516943	150-250 / 6"-10"	148 / 6"	250 / 10"	2 / 29	136 / 5.4"	520 / 21"	4.6 / 10	M 6	Not removable	3" (2")
520334	Bypass adapter R2" for PLUGSY 150-250 / 6"-10" VP1									
516944	200-300 / 8"-12"	198 / 8"	300 / 12"	2 / 29	186 / 7.3"	550 / 22"	7.6 / 17	M 6	Not removable	4" (2")
520341	Bypass adapter R2" for PLUGSY 200-300 / 8-12" VP1									
60967	150-300 / 6"-12"	150 / 6"	300 / 12"	1.5 / 22	142 / 5.6"	540 / 21"	3.6 / 8	M 8	-	2"
514953	Bypass adapter R2" for PLUGSY 150-300 / 6"-12" VP2									
60968	200-400 / 8"-16"	200 / 8"	400 / 16"	1.5 / 22	192 / 7.6"	600 / 25"	6.1 / 26	M 8	-	4" (2")
520344	Bypass adapter R2" for PLUGSY 200-400 / 8"-16" VP2									
514954	Bypass adapter R4" for PLUGSY 200-400 / 8"-16" VP2									
533539	300-525 / 12"-21"	300 / 12"	525 / 21"	1.5 / 22	272 / 10.7"	630 / 25"	11.7 / 35	M 10	R 1/4"	6" (4", 2")
534617	By pass adapter R4" for PLUGSY 300-525 / 12"-21" VP2									
534615	By pass adapter R6" for PLUGSY 300-525 / 12"-21" VP2									
60970	350-600 / 14"-24"	350 / 14"	600 / 24"	1.5 / 22	322 / 12.7"	830 / 33"	17 / 38	M 10	R 1/4"	6" (4", 2")
520347	Bypass adapter R4" for PLUGSY 350-600 / 14"-24" VP2									
514955	Bypass adapter R6" for PLUGSY 350-600 / 14"-24" VP2									
60971	500-1000 / 20"-40"	500 / 20"	1000 / 40"	1.5 / 22	472 / 18.6"	1150 / 45"	37.5 / 83	M 10	R 1/4"	8" (6", 4", 2")
520349	Bypass adapter R4" for PLUGSY 500-1000 / 20"-40" VP2									
520348	Bypass adapter R6" for PLUGSY 500-1000 / 20"-40" VP2									
514956	Bypass adapter R8" for PLUGSY 500-1000 / 20"-40" VP2									
535873	600-1200 / 24"-48"	600 / 24"	1200 / 48"	1.5 / 22	574 / 22.6"	1450 / 57"	65.1 / 144	M 12	2 × R 3/8"	6"
535874	600-1200 / 24"-48"	600 / 24"	1200 / 48"	1.5 / 22	574 / 22.6"	1450 / 57"	70.5 / 155	M 12	2 × R 3/8"	8"
535876	750-1500 / 30"-60"	750 / 30"	1500 / 60"	1 / 15	600 / 23.6"	2300 / 91"	79 / 174	M 12	2 × R 1/2"	6"
535878	750-1500 / 30"-60"	750 / 30"	1500 / 60"	1 / 15	600 / 23.6"	2300 / 91"	83 / 183	M 12	2 × R 1/2"	8"
535879	800-1800 / 32"-72"	800 / 32"	1800 / 72"	1 / 15	600 / 23.6"	3000 / 118"	121 / 267	M 12	2 × R 1/2"	6"
535880	800-1800 / 32"-72"	800 / 32"	1800 / 72"	1 / 15	800 / 31.5"	3000 / 118"	125 / 276	M 12	2 × R 1/2"	8"

**VP1** Plugs are supplied with a thread, a bypass adapter needed only if reducing the bypass size

**VP2** Plugs are supplied without a thread, therefore a bypass adapter is always required to ensure full functionality, it is sold separately in different sizes

**VP3** Plugs are supplied with a built-in adapter, which is included in plug's price



## BACK PRESSURES [BAR] / [psi]\*- PLUGSY VP

PLUG SIZE	PIPE DIAMETER [mm] / [inch]												
	100 / 4"	150 / 6"	200 / 8"	250 / 10"	300 / 12"	350 / 14"	400 / 16"	500 / 20"	600 / 24"	700 / 28"	800 / 32"	900 / 35"	1000 / 40"
100-150 / 4"-6"	1.0/15	0.8/12											
150-250 / 6"-10"		1.0/15	0.8/12	0.6/9									
200-300 / 8"-12"			1.0/15	0.8/12	0.6/9								
150-300 / 6"-12"		1.0/15	0.8/12	0.7/10	0.6/9								
200-400 / 8"-16"			1.1/16	0.9/13	0.7/10	0.6/9	0.6/9						
300-525 / 12"-21"					1.0/15	0.9/13	0.7/10	0.5/7					
350-600 / 14"-24"						0.9/13	0.8/12	0.7/10	0.6/9				
500-1000 / 20"-40"								1.1/16	0.9/13	0.8/12	0.7/10	0.6/9	0.6/9

## BACK PRESSURES [BAR] / [psi]\*- PLUGSY VP

PLUG SIZE	PIPE DIAMETER [mm] / [inch]									
	600 / 24"	800 / 32"	1000 / 40"	1200 / 48"	1300 / 52"	1400 / 56"	1500 / 60"	1600 / 64"	1700 / 68"	1800 / 72"
600-1200 / 24"-48"	1.0/15	0.8/12	0.6/9	0.5/7						
750-1500 / 30"-60"		1.0/15	0.9/13	0.7/10	0.6/9	0.5/7	0.4/6			
800-1800 / 32"-72"		1.0/15	1.0/15	0.8/12	0.8/12	0.7/10	0.6/9	0.5/7	0.4/6	0.4/6

\* measured in a dry iron pipe

# 1. 7.

## PROTECTION SLEEVES FOR PLUGS

SAVA protective sleeves prevent superficial cuts on the plug's surface and reduce the possibility of plug's damage due to sharp objects or debris in the damaged pipes. They do not affect the back pressure values of the plugs. They extend the service life of a plug and are especially suitable for frequent applications such as rental operations. They comply with our standard plug sizes. The handles on both sides facilitate pulling the sleeve over the plug.



Additional plug damage protection

Handles for easier manipulation

Also available in oil-resistant quality

Comply with standard plug sizes

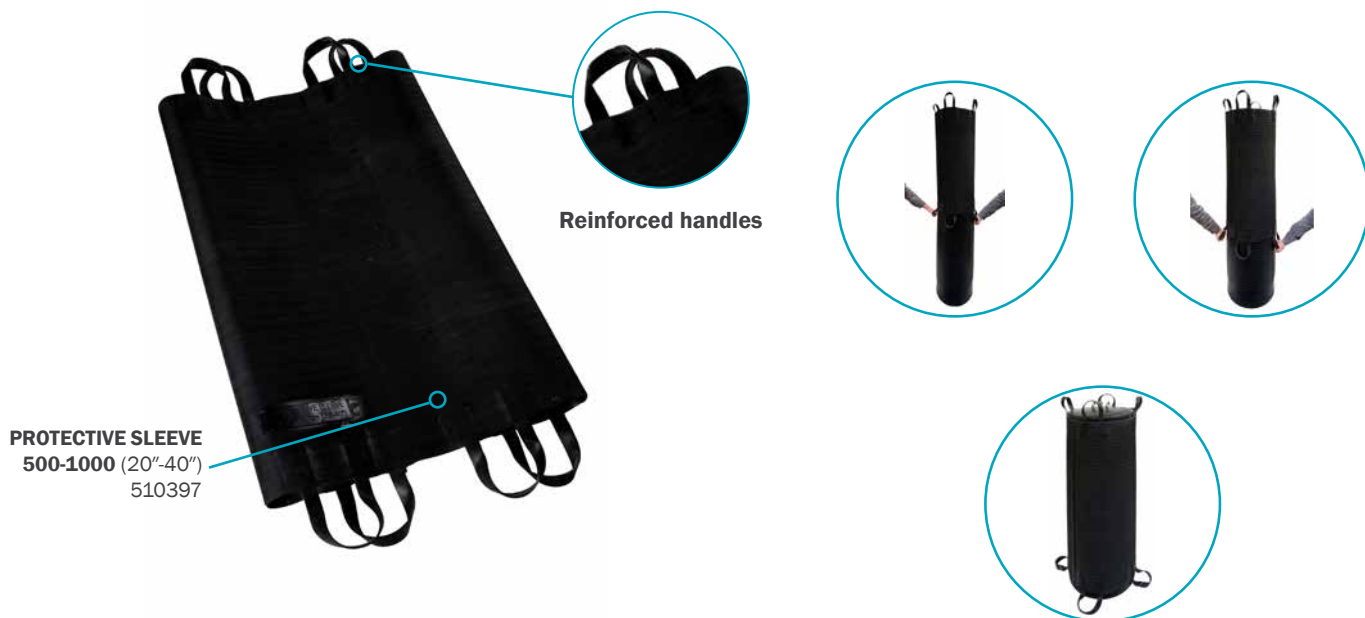

### PROTECTIVE SLEEVES

PART NUMBER	SIZE USAGE RANGE		LENGTH [mm] / [inch]	THICKNESS [mm] / [inch]	PRODUCT WEIGHT [kg] / [lbs]
	MIN. DIA. [mm] / [inch]	MAX. DIA. [mm] / [inch]			
577071	70 / 2.8"	150 / 6"	200 / 8"	1.5 / 0.06"	0.1 / 0.2
531489	100 / 4"	200 / 8"	400 / 16"	2 / 0.08"	0.3 / 0.7
525342	150 / 6"	300 / 12"	500 / 20"	3 / 0.12"	1 / 2
515570	200 / 8"	400 / 16"	600 / 24"	4 / 0.16"	1.6 / 4
536435	300 / 12"	525 / 21"	620 / 24"	4 / 0.16"	2.8 / 6
510395	350 / 14"	600 / 24"	800 / 32"	4 / 0.16"	3.5 / 8
510396	375 / 15"	750 / 30"	1000 / 39"	4 / 0.16"	4.6 / 10
510397	500 / 20"	1000 / 40"	1100 / 43"	4 / 0.16"	5.5 / 12
527496	600 / 24"	1200 / 48"	1300 / 51"	6 / 0.24"	16.9 / 37
510399	750 / 30"	1500 / 60"	2100 / 83"	6 / 0.24"	24.5 / 54
535884	800 / 32"	1800 / 72"	2300 / 91"	6 / 0.24"	29.7 / 66
565770	1000 / 40"	2400 / 96"	3500 / 138"	8 / 0.32"	108 / 238



# CHEMICAL-RESISTANT PLUGS MADE FROM CR RUBBER – PLUGY C AND PLUGSY C

1. 8.



SAVA PLUGY C and PLUGSY C are made from special CR rubber compound and are reinforced with aramid cord. Owing to their superb resistance to certain chemicals, they are ideal for use in the oil and gas industry.

Available in different sizes	Superb resistance to various liquids	Specially developed for use in refineries and food processing companies	CR rubber compound
------------------------------	--------------------------------------	---	--------------------



**NOTE:**  
Please check the table of resistance to various media in chapter 3.0.

## ACCESSORIES



**SINGLE FITTING CONTROLLER,**  
0.9 kg (2 lbs)  
2.5 bar (36 psi) 60310  
1.5 bar (22 psi) 74609  
1.0 bar (15 psi) 74653



**HAND HELD SINGLE DEADMAN**  
2.5 bar (36 psi),  
0.9 kg (2 lbs)  
519442



**INFLATION HOSE,**  
10 m (33'), **BLUE**  
1.2 kg (2.6 lbs)  
71248



**INFLATION HOSE,**  
10 m (33'), **YELLOW**  
1.2 kg (2.6 lbs)  
76686



**INFLATION HOSE,**  
10 m (33'), **RED**  
1.2 kg (2.6 lbs)  
74268



**POLY LIFT INFLATION HOSE,**  
5 m (16.4'), 1.9 kg (4.2 lbs) 60957  
10 m (33'), 2.4 kg (5.3 lbs) 60958



# CHEMICAL-RESISTANT PLUGS MADE FROM CR RUBBER – PLUGY C AND PLUGSY C

## 1. 8.

### PLUGY C - BLOCKING PLUGS

PART NUMBER	NOMINAL SIZE	SIZE USAGE RANGE		REQUIRED INFLATION PRESSURE [bar] / [psi]	DEFLATED PLUG		PRODUCT WEIGHT [kg] / [lbs]	EYE BOLT M THREAD	INFLATION VALVE THREAD SIZE
		MIN. DIA. [mm] / [inch]	MAX. DIA. [mm] / [inch]		DIAMETER [mm] / [inch]	RUBBER LENGTH [mm] / [inch]			
526621	40-70 / 1.6"-2.8"	40 / 1.6"	70 / 2.8"	2.5 / 36	35 / 1.4"	160 / 6"	0.2 / 0.4	NA	R 1/4"
526622	70-150 / 2.8"-6"	70 / 2.8"	150 / 6"	2.5 / 36	68 / 2.7"	300 / 12"	0.4 / 0.9	NA	R 1/4"
60506	100-200 / 4"-8"	100 / 4"	200 / 8"	2.5 / 36	92 / 3.6"	500 / 20"	1.35 / 3	M6	R 1/4"
60507	150-300 / 6"-12"	150 / 6"	300 / 12"	2.5 / 36	142 / 5.6"	540 / 21"	2.6 / 6	M8	R 1/4"
60510	200-400 / 8"-16"	200 / 8"	400 / 16"	2.5 / 36	192 / 7.6"	600 / 24"	3.6 / 8	M8	R 1/4"
526623	300-525 / 12"-21"	300 / 12"	525 / 21"	2.5 / 36	272 / 10.7"	630 / 25"	6.8 / 15	M8	R 1/4"
60511	350-600 / 14"-24"	350 / 14"	600 / 24"	2.5 / 36	322 / 12.7"	830 / 33"	9.8 / 22	M10	R 1/4"
526624	375-750 / 15"-30"	375 / 15"	750 / 30"	2.5 / 36	342 / 13.5"	1050 / 41"	11.9 / 26	M10	R 1/4"
526625	500-800 / 20"-32"	500 / 20"	800 / 32"	2.5 / 36	472 / 18.6"	1150 / 45"	19.5 / 43	M10	R 1/4"
510070	500-1000 / 20"-40"	500 / 20"	1000 / 40"	1.5 / 22	472 / 18.6"	1150 / 45"	19.5 / 43	M10	R 1/4"
526626	600-1200 / 24"-48"	600 / 24"	1200 / 48"	1.5 / 22	574 / 22.6"	1450 / 57"	38 / 84	M10	2 x R 3/8"

### PLUGSY C - BYPASS PLUGS

PART NUMBER	NOMINAL SIZE	SIZE USAGE RANGE		REQUIRED INFLATION PRESSURE [bar] / [psi]	DEFLATED PLUG		PRODUCT WEIGHT [kg] / [lbs]	EYE BOLT M THREAD	INFLATION VALVE THREAD SIZE	BYPASS DIAMETER (FEMALE)
		MIN. DIA. [mm] / [inch]	MAX. DIA. [mm] / [inch]		DIAMETER [mm] / [inch]	RUBBER LENGTH [mm] / [inch]				
526637	100-200 / 4"-8"	100 / 4"	200 / 8"	2.5 / 36	92 / 3.6"	500 / 20"	2.7 / 6	M6	R 1/4"	1"
526636	150-300 / 6"-12"	150 / 6"	300 / 12"	2.5 / 36	142 / 5.6"	540 / 21"	4.3 / 9	M8	R 1/4"	1"
526635	200-400 / 8"-16"	200 / 8"	400 / 16"	2.5 / 36	192 / 7.6"	600 / 24"	7 / 15	M8	R 1/4"	2"
526634	300-525 / 12"-21"	300 / 12"	525 / 21"	2.5 / 36	272 / 10.7"	630 / 25"	12 / 26	M8	R 1/4"	2"
526633	350-600 / 14"-24"	350 / 14"	600 / 24"	2.5 / 36	322 / 12.7"	830 / 33"	16 / 35	M10	R 1/4"	2"
526631	375-750 / 15"-30"	375 / 15"	750 / 30"	2.5 / 36	342 / 13.5"	1050 / 41"	19.7 / 43	M10	R 1/4"	2"
526629	500-800 / 20"-32"	500 / 20"	800 / 32"	2.5 / 36	472 / 18.6"	1150 / 45"	32.5 / 72	M10	R 1/4"	2"
526628	500-1000 / 20"-40"	500 / 20"	1000 / 40"	1.5 / 22	472 / 18.6"	1150 / 45"	32.5 / 72	M10	R 1/4"	2"
526627	600-1200 / 24"-48"	600 / 24"	1200 / 48"	1.5 / 22	574 / 22.6"	1450 / 57"	55.5 / 122	M10	2 x R 3/8"	4"

### BACK PRESSURES [bar] / [psi]\* - PLUGY C, PLUGSY C

PLUG SIZE	PIPE DIAMETER [mm] / [inch]													
	40 / 1.5"	70 / 2.8"	100 / 4"	150 / 6"	200 / 8"	250 / 10"	300 / 12"	350 / 14"	400 / 16"	500 / 20"	600 / 24"	800 / 32"	1000 / 40"	1200 / 48"
40-70 / 1.6"-2.8"	2.0/29	1.2/17												
70-150 / 2.8"-6"		2.2/32	1.7/25	1.3/19										
100-200 / 4"-8"			2.2/32	1.7/25	1.3/19									
150-200 / 6"-8"				2.0/29	1.5/22									
150-300 / 6"-12"				2.2/32	2.0/29	1.4/20	1.2/17							
200-400 / 8"-16"					2.2/32	2.0/29	1.7/25	1.5/22	1.2/17					
300-525 / 12"-21"							2.0/29	1.7/25	1.5/22	1.2/17				
350-600 / 14"-24"								2.1/30	1.9/28	1.6/23	1.3/19			
375-750 / 15"-30"									2.0/29	1.7/25	1.4/20			
500-800 / 20"-32"										1.8/26	1.4/20	1.1/16		
500-1000 / 20"-40"										1.0/15	0.8/12	0.6/9	0.5/7	
600-1200 / 24"-48"											1.0/15	0.7/10	0.6/9	0.5/7

\* measured in a dry iron pipe



TYPE 26 - INOX

# CHEMICAL-RESISTANT PLUGS MADE FROM NBR RUBBER – PLUGY NBR

1. 9.

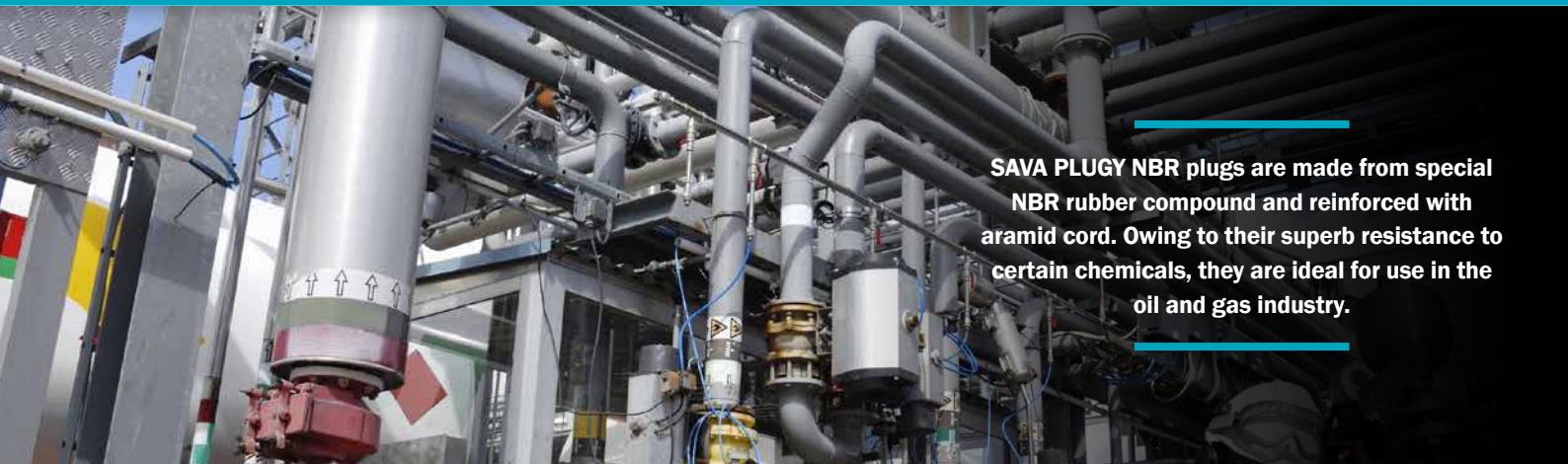

SAVA PLUGY NBR plugs are made from special NBR rubber compound and reinforced with aramid cord. Owing to their superb resistance to certain chemicals, they are ideal for use in the oil and gas industry.

<b>NBR rubber compound</b>	<b>Superb resistance to various liquids</b>	<b>Specially developed for use in refineries and food processing companies</b>	<b>Stainless steel connections</b>
----------------------------	---	--	------------------------------------

### SUPERB RESISTANCE OF PLUGS APPLIES TO:

- Most mineral oils and mineral-oil based greases
- Normal fuels like gasoline, diesel and light heating oils
- Animal and vegetable oils and fats
- Temperature resistance from -10°C (14°F) to +80°C (176°F)

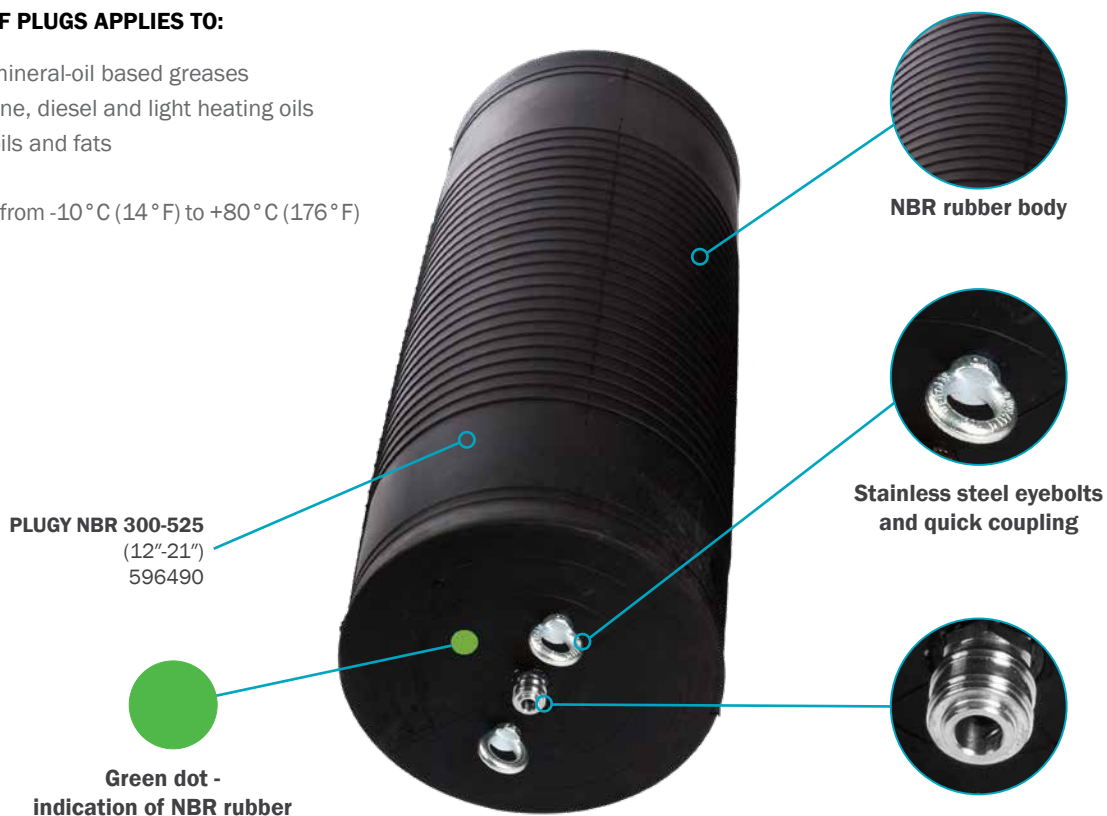

### ACCESSORIES



**SINGLE FITTING CONTROLLER,**  
0.9 kg (2 lbs)  
2.5 bar (36 psi) 60310  
1.5 bar (22 psi) 74609



**HAND HELD SINGLE DEADMAN**  
2.5 bar (36 psi),  
0.9 kg (2 lbs)  
519442



**INFLATION HOSE EPDM-INOX CONNECTORS,**  
10 m (33'),  
3 kg (6.6 lbs)  
582559

# CHEMICAL-RESISTANT PLUGS MADE FROM

## 1. 9.

## NBR RUBBER – PLUGY NBR

**CHEMICAL RESISTANCE TABLE**

MEDIUM	TEMPERATURE [°C] / [°F]	NR/BR	CR	NBR
Ethane		4	2	1
Kerosene	70 / 158	4	3	1
Liquified petroleum gas		4	2	1
Methane	23 / 73.4	4	3	1
Naphtha	23 / 73.4	4	4	1
Natural gas		3	1	1
Oil 1 (ASTM No.1, ISO 1817)	100 / 212	4	1	1
Oil 2 (IRM 902, ISO 1817)	100 / 212	4	2	1
Oil 3 (IRM 903, ISO 1817)	100 / 212	4	4	1

■ 1 - no / insignificant effect  
 ■ 2 - minor effect  
 ■ 3 - moderate effect  
 ■ 4 - severe effect

NR/BR - standard plugs from natural rubber mixture

CR - oil-resistant plugs from Chloroprene rubber - Type C

NBR - oil-resistant plugs from Nitrile rubber - Type NBR

**PLUGY NBR - BLOCKING PLUGS**

PART NUMBER	NOMINAL SIZE	SIZE USAGE RANGE		REQUIRED INFLATION PRESSURE [bar] / [psi]	DEFLATED PLUG DIMENSIONS		PRODUCT WEIGHT [kg] / [lbs]	EYE BOLT M THREAD	INFLATION VALVE THREAD SIZE
		MIN. DIA. [mm] / [inch]	MAX. DIA. [mm] / [inch]		DIAMETER [mm] / [inch]	LENGTH [mm] / [inch]			
596487	100-200 / 4"-8"	100 / 4"	200 / 8"	2.5 / 36	92 / 3.6	500 / 20"	1.3 / 3	M6	R 1/4"
596488	150-300 / 6"-12"	150 / 6"	300 / 12"	2.5 / 36	142 / 5.6"	540 / 21"	2.6 / 6	M8	R 1/4"
596489	200-400 / 8"-16"	200 / 8"	400 / 16"	2.5 / 36	192 / 7.6"	600 / 24"	3.6 / 8	M8	R 1/4"
596490	300-525 / 12"-21"	300 / 12"	525 / 21"	2.5 / 36	272 / 10.7"	630 / 25"	6.8 / 15	M8	R 1/4"
596491	350-600 / 14"-24"	350 / 14"	600 / 24"	2.5 / 36	322 / 12.7"	830 / 33"	9.8 / 22	M10	R 1/4"
596492	500-800 / 20"-32"	500 / 20"	800 / 32"	2.5 / 36	472 / 18.6"	1150 / 45"	28.0 / 62	M10	R 1/4"
602226	500-1000 / 20"-40"	500 / 20"	1000 / 40"	1.5 / 22	472 / 18.6"	1150 / 45"	32.5 / 72	M10	R 1/4"
596493	600-1200 / 24"-48"	600 / 24"	1200 / 48"	1.5 / 22	574 / 22.6"	1450 / 57"	45.5 / 100	M10	R 1/4"

**BACK PRESSURES [BAR] / [psi]\*- PLUGY NBR**

PLUG SIZE	PIPE DIAMETER [mm] / [inch]											
	100 / 4"	150 / 6"	200 / 8"	250 / 10"	300 / 12"	350 / 14"	400 / 16"	500 / 20"	600 / 24"	800 / 32"	1000 / 40"	1200 / 48"
100-200 / 4"-8"	2.2/32	1.7/25	1.0/15									
150-300 / 6"-12"		2.2/32	1.7/25	1.3/19								
200-400 / 8"-16"			2.2/32	2.0/29	1.7/25	1.6/23	1.5/22					
300-525 / 12"-21"					2.0/29	1.7/25	1.6/23	1.5/22				
350-600 / 14"-24"						2.1/30	1.9/28	1.6/23	1.5/22			
500-800 / 20"-32"								1.8/26	1.4/20	1.2/17		
500-1000 / 20"-40"								1.0/15	0.8/12	0.6/9	0.5/7	
600-1200 / 24"-48"									1.0/15	0.7/10	0.6/9	0.5/7

\* measured in a dry iron pipe



# CONE-SHAPED PLUGS – PLUGY CP AND PLUGSY CP

1. 10.



SAVA CONE PLUGY CP plugs are available in dimensions from 400 mm - 2400 mm (16" - 95'). They are produced from special CR rubber and reinforced with fabric. The additional sealing foam improves sealing in all conditions. Plugs are equipped with carrying handles and eyelets for easier manipulation. They are very light and suitable for sealing pipes of various shapes (cone, oval, etc..).

Repairable material

Wide range

Conical shape

Light- weight



## CONE PLUGY CP - BLOCKING PLUGS

PART NUMBER	NOMINAL SIZE	SIZE USAGE RANGE		REQUIRED INFLATION PRESSURE [bar] / [psi]	INFLATED PLUG		BACK PRESSURE* [bar] / [psi]	INFLATION VALVE
		MIN. DIA. [mm] / [inch]	MAX. DIA. [mm] / [inch]		WEIGHT [kg] / [lbs]	LENGTH [mm] / [inch]		THREAD SIZE
574340	400-1000 / 16"-40"	400 / 16"	1000 / 40"	1 / 15	16.6 / 37	2000 / 79"	0.5 / 7	R1/2"
574341	600-1500 / 24"-60"	600 / 24"	1500 / 60"	1 / 15	35.7 / 79	3000 / 118"	0.5 / 7	R1/2"
574342	700-2000 / 28"-80"	700 / 28"	2000 / 80"	1 / 15	83.8 / 185	3600 / 142"	0.5 / 7	R1/2"
574343	900-2400 / 35"-96"	900 / 35"	2400 / 96"	1 / 15	111.5 / 246	4800 / 189"	0.5 / 7	R1/2"

\* back pressure 0.5 bar (7 psi) water or 0.2 bar (3 psi) air/vacuum



# 1. 10. CONE-SHAPED PLUGS – PLUGY CP AND PLUGSY CP

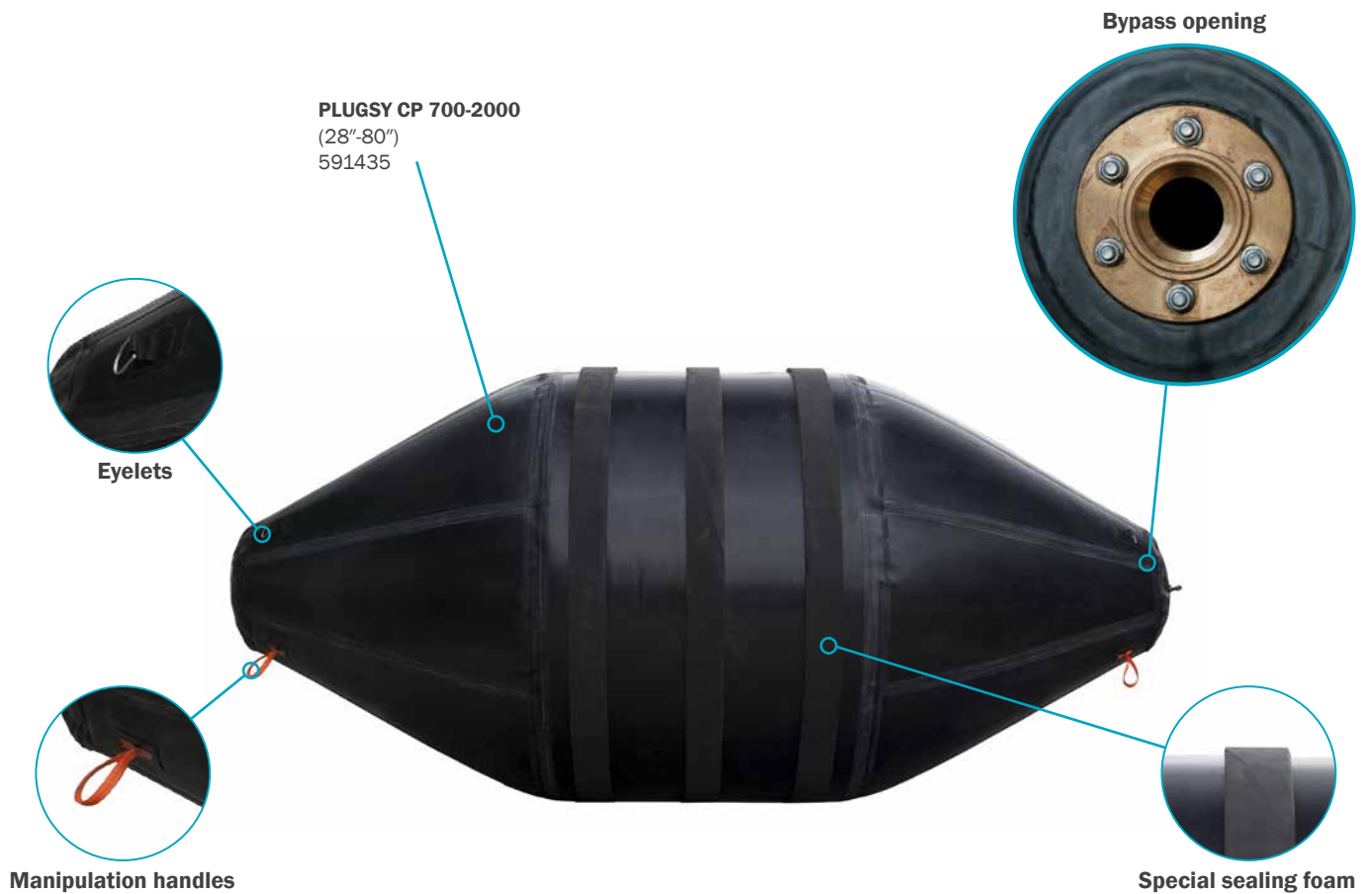

## CONE PLUGSY CP - BYPASS PLUGS

PART NUMBER	NOMINAL SIZE	SIZE USAGE RANGE		REQUIRED INFLATION PRESSURE [bar] / [psi]	INFLATED PLUG		BYPASS DIAMETER (FEMALE)	INFLATION VALVE
		MIN. DIA. [mm] / [inch]	MAX. DIA. [mm] / [inch]		WEIGHT [kg] / [lbs]	LENGTH [mm] / [inch]		THREAD SIZE
591433	400-1000 / 16"-40"	400 / 16"	1000 / 40"	1 / 15	22.5 / 50	2000 / 79"	2"	R1/2"
591434	600-1500 / 24"-60"	600 / 24"	1500 / 60"	1 / 15	43.1 / 95	3000 / 118"	2"	R1/2"
591435	700-2000 / 28"-80"	700 / 28"	2000 / 80"	1 / 15	92.2 / 203	3600 / 142"	2"	R1/2"
591436	900-2400 / 35"-96"	900 / 35"	2400 / 96"	1 / 15	122.5 / 270	4800 / 189"	2"	R1/2"

## ACCESSORIES



**SINGLE FITTING CONTROLLER**  
1.0 bar (14.5 psi)  
1.0 kg (2.2 lbs)  
551503



**INFLATION HOSE 10 m (33')**  
**WITH SAFETY GEKA**  
**COUPLING, 3.0 kg (6.6 lbs)**  
519817



# ROUND-SHAPED PLUGS – PLUGSY B-VP

1. 11.

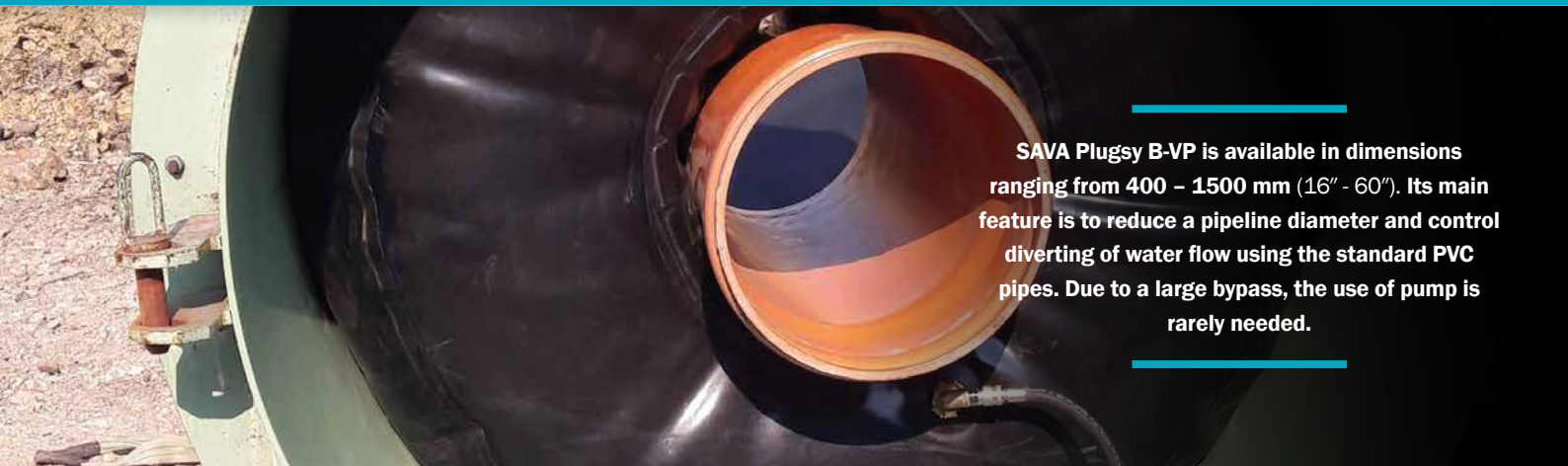

SAVA Plugsy B-VP is available in dimensions ranging from 400 – 1500 mm (16" - 60"). Its main feature is to reduce a pipeline diameter and control diverting of water flow using the standard PVC pipes. Due to a large bypass, the use of pump is rarely needed.

Highly flexible	Lightweight	Wide bypass system
-----------------	-------------	--------------------

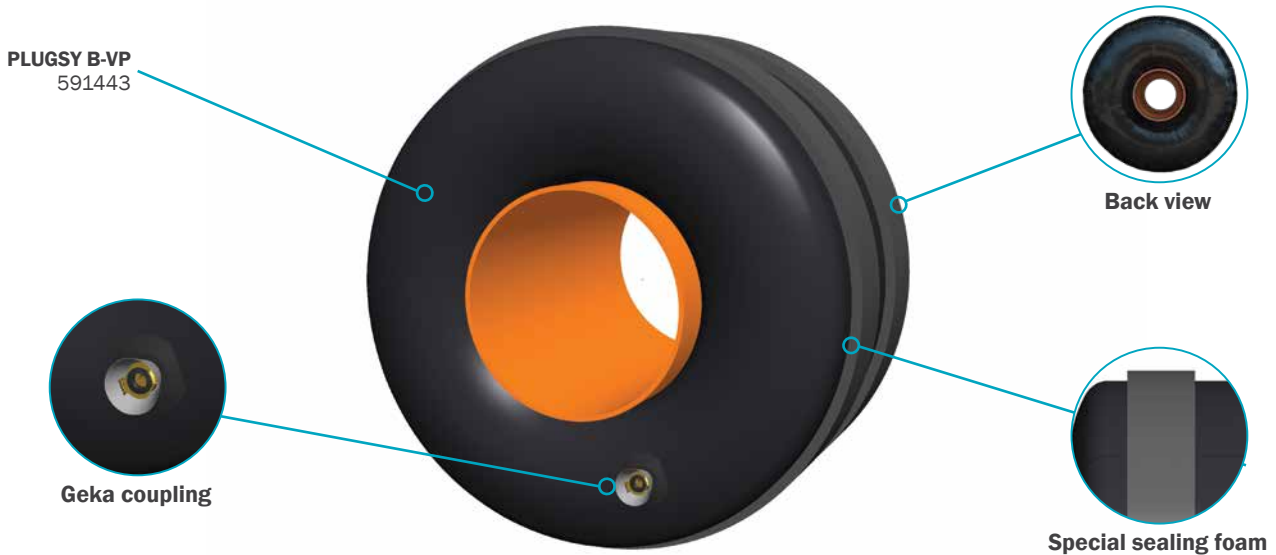

\*PVC pipe is not included with the product.

## PLUGSY B-VP - BYPASS PLUGS

PART NUMBER	NOMINAL SIZE	SIZE USAGE RANGE		REQUIRED INFLATION PRESSURE [bar] / [psi]	INFLATED PLUG		BYPASS DIAMETER OUTER DIAMETER MAX. [mm] / [inch]	INFLATION VALVE
		MIN. DIA. [mm] / [inch]	MAX. DIA. [mm] / [inch]		WEIGHT [kg] / [lbs]	LENGTH [mm] / [inch]		THREAD SIZE
591443	400-1000 / 16"-40"	400 / 16"	1000 / 40"	1 / 15	15 / 33	600 / 24"	250 / 10"	R1/2"
591445	600-1500 / 24"-60"	600 / 24"	1500 / 60"	1 / 15	25 / 55	720 / 28"	460 / 18"	R1/2"

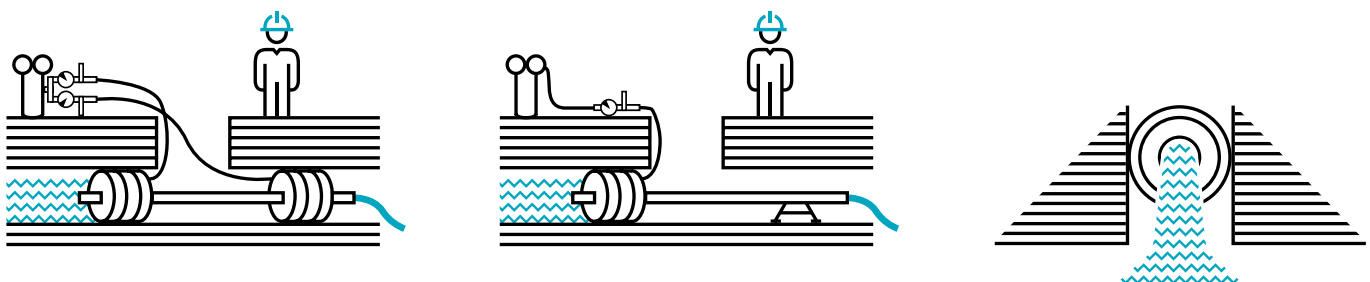



The unique construction and high-quality materials of SAVA pillow-shaped PLUGY PILLOW and PLUGSY PILLOW plugs ensure low weight and high flexibility during use and storage. Plugs of this type are suitable for the largest pipelines and can be custom-made to fit any pipeline diameter.



Flexible and fully foldable

Small insertion diameter required

Fit through a 600 mm (24") manhole

Custom-made dimensions available



Deflated Pillow



Folded Pillow



**PLUGY PILLOW 600-1000**  
(24"-40")  
529411

## ACCESSORIES



**SINGLE FITTING CONTROLLER**  
1.0 bar (14.5 psi)  
1.0 kg (2.2 lbs)  
551503



**INFLATION HOSE 10 m (33') WITH SAFETY GEKA COUPLING, 3.0 kg (6.6 lbs)**  
519817



**ADAPTER GEKA/26, 0.2 kg (0.4 lbs)**  
575711

# PILLOW-SHAPED PLUGS – PLUGY PILLOW AND PLUGSY PILLOW

**1. 12.**

## PLUGY PILLOW - BLOCKING PLUGS

PART NUMBER	NOMINAL SIZE	SIZE USAGE RANGE		REQUIRED INFLATION PRESSURE [bar] / [psi]	MAX. ALLOWABLE BACK PRESSURE		DEFLATED PLUG			PRODUCT WEIGHT [kg] / [lbs]	SHACKLE M THREAD	INFLATION VALVE THREAD SIZE
		MIN. DIA. [mm] / [inch]	MAX. DIA. [mm] / [inch]		WATER HEAD [bar] / [psi]	WATER HEAD [m] / [ft]	DIAMETER [mm] / [inch]	WIDTH [mm] / [inch]	LENGTH [mm] / [inch]			
529411	600-1000 / 24"-40"	600 / 24"	1000 / 40"	1 / 15	0.7 / 10	7 / 23'	580 / 23"	910 / 36"	2100 / 83"	18 / 40	12 x 2	2 x R1/2"
529412	800-1200 / 32"-48"	800 / 32"	1200 / 48"	0.9 / 13	0.6 / 9	6 / 19.7'	780 / 31"	1230 / 48"	2500 / 98"	29 / 64	12 x 2	2 x R1/2"
529413	1200-1600 / 48"-64"	1200 / 48"	1600 / 64"	0.8 / 12	0.5 / 7	5 / 16.4'	1170 / 44"	1830 / 72"	3200 / 126"	51 / 112	12 x 3	2 x R1/2"
529414	1600-2000 / 64"-80"	1600 / 64"	2000 / 80"	0.6 / 9	0.4 / 6	4 / 13.1'	1560 / 61"	2450 / 97"	4000 / 157"	86 / 190	12 x 3	2 x R1/2"
529491	1900-2200 / 76"-88"	1900 / 76"	2200 / 88"	0.5 / 7	0.3 / 4	3 / 9.8'	1850 / 73"	2910 / 114"	4800 / 189"	100 / 221	12 x 4	2 x R1/2"
545429	2400-2500 / 96"-100"	2400 / 96"	2500 / 100"	0.5 / 7	0.3 / 4	3 / 9.8'	2350 / 93"	3690 / 145"	5600 / 220"	222 / 489	12 x 6	2 x R1/2"

## PLUGSY PILLOW - BYPASS PLUGS

PART NUMBER	NOMINAL SIZE	SIZE USAGE RANGE		REQUIRED INFLATION PRESSURE [bar] / [psi]	MAX. ALLOWABLE BACK PRESSURE		DEFLATED PLUG			PRODUCT WEIGHT [kg] / [lbs]	SHACKLE M THREAD	INFLATION VALVE THREAD SIZE	BYPASS DIAMETER (FEMALE)
		MIN. DIA. [mm] / [inch]	MAX. DIA. [mm] / [inch]		WATER HEAD [bar] / [psi]	WATER HEAD [m] / [ft]	DIAMETER [mm] / [inch]	WIDTH [mm] / [inch]	LENGTH [mm] / [inch]				
529415	600-1000 / 24"-40"	600 / 24"	1000 / 40"	1 / 15	0.7 / 10	7 / 23'	580 / 23"	910 / 36"	2100 / 83"	23 / 51	12 x 2	2 x R1/2"	2"
529416	800-1200 / 32"-48"	800 / 32"	1200 / 48"	0.9 / 13	0.6 / 9	6 / 19.7'	780 / 31"	1230 / 48"	2500 / 98"	34 / 75	12 x 2	2 x R1/2"	2"
529417	1200-1600 / 48"-64"	1200 / 48"	1600 / 64"	0.8 / 12	0.5 / 7	5 / 16.4'	1170 / 44"	1830 / 72"	3200 / 126"	57 / 126	12 x 3	2 x R1/2"	2"
529418	1600-2000 / 64"-80"	1600 / 64"	2000 / 80"	0.6 / 9	0.4 / 6	4 / 13.1'	1560 / 61"	2450 / 97"	4000 / 157"	92 / 203	12 x 3	2 x R1/2"	2"
529492	1900-2200 / 76"-88"	1900 / 76"	2200 / 88"	0.5 / 7	0.3 / 4	3 / 9.8'	1850 / 73"	2910 / 114"	4800 / 189"	100 / 221	12 x 4	2 x R1/2"	2"
545433	2400-2500 / 96"-100"	2400 / 96"	2500 / 100"	0.5 / 7	0.3 / 4	3 / 9.8'	2350 / 93"	3690 / 145"	5600 / 220"	234 / 516	12 x 6	2 x R1/2"	2"



Inserting a folded pillow plug



Placing – pillow plug should be positioned horizontally



Inflated pillow plug



# EGG-SHAPED PLUGS – PLUGY EI, PLUGY EI PILLOW AND PLUGSY EI, PLUGSY EI PILLOW



1. 13.

The shape of the first two sizes is adapted to the shape of the pipeline, while the larger sizes are pillow-shaped to simplify insertion through the manholes. Plugs are available in seven standard sizes, both sealing and bypass types.



Fit all standard egg-shaped pipes

Two design versions

Wide range

## EI DESIGN (FOR SMALL SIZES)



## EI PILLOW DESIGN (FOR LARGER SIZES)

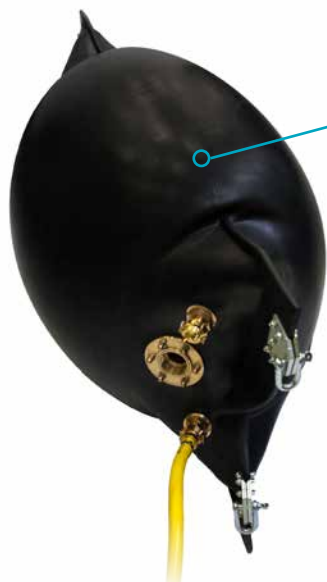

**!** NOTE:  
Pillow EI plug should be placed vertically





# EGG-SHAPED PLUGS – PLUGY EI, PLUGY EI PILLOW AND PLUGSY EI, PLUGSY EI PILLOW

1. 13.

## ACCESSORIES EI DESIGN



**SINGLE FITTING CONTROLLER,**  
0.9 kg (2 lbs)  
1.5 bar (22 psi)  
74609



**INFLATION HOSE,**  
10 m (33'), RED  
1.2 kg (2.6 lbs)  
74268



**INFLATION HOSE,**  
10 m (33'), BLUE  
1.2 kg (2.6 lbs)  
71248



**INFLATION HOSE,**  
10 m (33'), YELLOW  
1.2 kg (2.6 lbs)  
76686



**POLY LIFT INFLATION HOSE,**  
5 m (16.4'), 1.9 kg (4.2 lbs)  
60957



**POLY LIFT INFLATION HOSE,**  
10 m (33'), 2.4 kg (5.3 lbs)  
60958

## ACCESSORIES EI PILLOW DESIGN



**SINGLE FITTING CONTROLLER**  
1.0 bar (14.5 psi)  
1.0 kg (2.2 lbs)  
551503



**INFLATION HOSE 10 m (33') WITH SAFETY GEKA COUPLING,**  
3.0 kg (6.6 lbs)  
519817

### PLUGY EI - BLOCKING PLUGS

PART NUMBER	NOMINAL SIZE	SIZE USAGE RANGE		REQUIRED INFLATION PRESSURE [bar] / [psi]	MAX. ALLOWED BACK PRESSURE		DEFLATED PLUG			PRODUCT WEIGHT [kg] / [lbs]	EYE BOLT	SHACKLE	INFLATION VALVE
		MIN. DIA. [mm] / [inch]	MAX. DIA. [mm] / [inch]		WATER HEAD [bar] / [psi]	WATER HEAD [m] / [ft]	DIAMETER [mm] / [inch]	WIDTH [mm] / [inch]	LENGTH [mm] / [inch]				
503485	EI 1	200/300 / 8"/12"	250/375 / 10"/15"	1.5 / 22	0.5 / 7	5 / 16.4'	180x265 / 7.1"x10.4"	/	600 / 24"	7 / 15	8	NA	TYPE 26
503486	EI 2	300/450 / 12"/18"	350/525 / 14"/21"	1.5 / 22	0.5 / 7	5 / 16.4'	280x415 / 11"x16.3"	/	700 / 28"	14.8 / 33	8	NA	TYPE 26
526694	EI 3 - PILLOW	400/600 / 16"/24"	500/750 / 20"/30"	1.3 / 19	0.5 / 7	5 / 16.4'	420 / 16.5"	660 / 26"	1800 / 71"	20.1 / 44	NA	12 x 2	2 x R1/2"
568807	EI 3s - PILLOW	600/900 / 24"/35"	600/900 / 24"/35"	1.3 / 19	0.5 / 7	5 / 16.4'	636 / 25"	1000 / 40"	1800 / 71"	26.7 / 59	NA	12 x 2	2 x R1/2"
519444	EI 4 - PILLOW	700/1050 / 28"/41"	800/1200 / 32"/48"	0.9 / 13	0.5 / 7	5 / 16.4'	751 / 29.6"	1180 / 47"	2300 / 91"	36.1 / 79	NA	12 x 2	2 x R1/2"
519447	EI 5 - PILLOW	900/1350 / 35"/53"	1000/1500 / 40"/60"	0.8 / 12	0.5 / 7	5 / 16.4'	955 / 37.6"	1500 / 59"	2900 / 114"	53.9 / 119	NA	12 x 3	2 x R1/2"
536345	EI 6 - PILLOW	1200/1800 / 48"/72"	1400/2100 / 56"/84"	0.6 / 9	0.4 / 6	4 / 13.1'	1394 / 54.9"	2190 / 86"	3400 / 134"	92.4 / 204	NA	12 x 3	2 x R1/2"

### PLUGSY EI - BYPASS PLUGS

PART NUMBER	NOMINAL SIZE	SIZE USAGE RANGE		REQUIRED INFLATION PRESSURE [bar] / [psi]	MAX. ALLOWED BACK PRESSURE		DEFLATED PLUG			PRODUCT WEIGHT [kg] / [lbs]	EYE BOLT	SHACKLE	BYPASS DIAMETER
		MIN. DIA. [mm] / [inch]	MAX. DIA. [mm] / [inch]		WATER HEAD [bar] / [psi]	WATER HEAD [m] / [ft]	DIAMETER [mm] / [inch]	WIDTH [mm] / [inch]	LENGTH [mm] / [inch]				
504158	EI 1	200/300 / 8"/12"	250/375 / 10"/15"	1.5 / 22	0.5 / 7	5 / 16.4'	180x265 / 7.1"x10.4"	/	600 / 24"	10.2 / 23	8	NA	2"
504160	EI 2	300/450 / 12"/18"	350/525 / 14"/21"	1.5 / 22	0.5 / 7	5 / 16.4'	280x415 / 11"x16.3"	/	700 / 28"	17.9 / 40	8	NA	3"
526695	EI 3 - PILLOW	400/600 / 16"/24"	500/750 / 20"/30"	1.3 / 19	0.5 / 7	5 / 16.4'	420 / 16.5"	660 / 26"	1800 / 71"	25.4 / 60	NA	12 x 2	2"
568808	EI 3s - PILLOW	600/900 / 24"/35"	600/900 / 24"/35"	1.3 / 19	0.5 / 7	5 / 16.4'	636 / 25"	1000 / 40"	1800 / 71"	32.1 / 71	NA	12 x 2	2"
519448	EI 4 - PILLOW	700/1050 / 28"/41"	800/1200 / 32"/48"	0.9 / 13	0.5 / 7	5 / 16.4'	751 / 29.6"	1180 / 47"	2300 / 91"	42.1 / 93	NA	12 x 2	2"
519449	EI 5 - PILLOW	900/1350 / 35"/53"	1000/1500 / 40"/60"	0.8 / 12	0.5 / 7	5 / 16.4'	955 / 37.6"	1500 / 59"	2900 / 114"	60.8 / 134	NA	12 x 3	2"
536350	EI 6 - PILLOW	1200/1800 / 48"/72"	1400/2100 / 56"/84"	0.6 / 9	0.4 / 6	4 / 13.1'	1394 / 54.9"	2190 / 86"	3400 / 134"	100.9 / 222	NA	12 x 3	2"

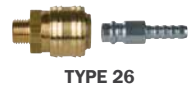

# 1. 14.

## MANHOLE PLUGS – PLUGSY VJ

SAVA PLUGSY VJ for manhole tightness testings are short and light, equipped with three eyebolts for a simple vertical insertion of a plug.

Suitable for EN 1610 testing

Special narrow design to fit manhole

Simple handling

Heavy duty



PLUGSY VJ SINGLE-SIZE DESIGN (VJ 600, VJ 800, VJ 1000)



PLUGSY VJ MULTI-SIZE DESIGN (VJ 600-650)

### PLUGSY VJ - BYPASS PLUGS

PART NUMBER	NOMINAL SIZE	SIZE USAGE RANGE		REQUIRED INFLATION PRESSURE [bar] / [psi]	DEFLATED PLUG		PRODUCT WEIGHT [kg] / [lbs]	INFLATION VALVE THREAD SIZE	BYPASS DIAMETER (FEMALE)
		MIN. DIA. [mm] / [inch]	MAX. DIA. [mm] / [inch]		DIAMETER [mm] / [inch]	LENGTH [mm] / [inch]			
501841	600-650 / 24"-26"	600 / 24"	650 / 26"	1.5 / 22	560 / 22"	360 / 14"	16 / 35	R 1/4"	2"
538201	600 / 24"	590 / 23"	600 / 24"	0.5 / 7	582 / 22.9"	200 / 8"	3.7 / 8	R 1/4"	2"
573713	700 / 28"	690 / 27"	700 / 28"	0.5 / 7	670 / 26"	200 / 8"	4.6 / 10.1	R 1/4"	2"
535889	800 / 32"	780 / 30.7"	800 / 32"	0.5 / 7	770 / 30"	200 / 8"	5 / 11	R 1/4"	2"
535890	1000 / 40"	980 / 38.5"	1000 / 40"	0.5 / 7	970 / 38"	200 / 8"	6.5 / 14	R 1/4"	2"



**TYPE 26** (6 bar / 87 psi,  
12 bar / 435 psi)

# HIGH-PRESSURE PLUGS - PLUGY HP 6 bar (87 psi), 12 bar (174 psi) AND 30 bar (435 psi)

**1. 15.**



SAVA PLUGY HP plugs are specially reinforced plugs suitable for sealing of pipes with extremely high back pressures.

**Special reinforcement**

**High back pressures**

**Heavy duty**

**PLUGY HP 6 bar** (435 psi)  
**350 - 500** (14"-20")  
60909



**PLUGY HP 6 bar** (87 psi), **12 bar** (174 psi)

**PLUGY HP 30 bar** (435 psi) **DESIGN**



**PLUGY HP 30 bar** (435 psi)  
537323

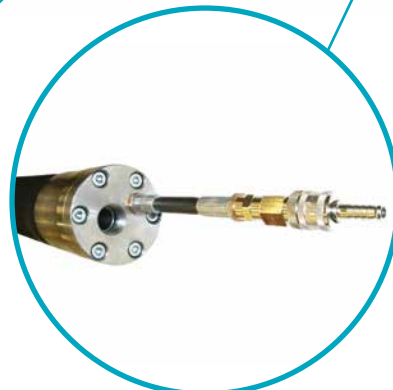

**Front view**

## ACCESSORIES 6 bar (87 psi) AND 12 bar (174 psi)



**SINGLE FITTING CONTROLLER,**  
**0.9 kg** (2 lbs)  
**12 bar** (174 psi) 531544  
**6 bar** (87 psi) 531542



**INFLATION HOSE, RED**  
**10 m** (33')  
**1.2 kg** (2.6 lbs)  
74268



**INFLATION HOSE, BLUE**  
**10 m** (33')  
**1.2 kg** (2.6 lbs)  
71248



**INFLATION HOSE, YELLOW**  
**10 m** (33')  
**1.2 kg** (2.6 lbs)  
76686



**POLY LIFT INFLATION HOSE,**  
**5 m** (16.4'),  
**1.9 kg** (4.2 lbs)  
60957



**POLY LIFT INFLATION HOSE,**  
**10 m** (33'),  
**2.4 kg** (5.3 lbs)  
60958



# 1. 15. HIGH-PRESSURE PLUGS – PLUGY HP 6 bar (87 psi), 12 bar (174 psi) AND 30 bar (435 psi)



## ACCESSORIES 30 bar (435 psi)



**SINGLE FITTING CONTROLLER,**  
0.9 kg (2 lbs)  
30 bar (435 psi)  
282184



**INFLATION HOSE,**  
10 m (33'),  
4 kg (8.8 lbs)  
546714

### PLUGY HP 6 bar (87 psi) - BLOCKING PLUGS

PART NUMBER	NOMINAL SIZE	SIZE USAGE RANGE		REQUIRED INFLATION PRESSURE [bar] / [psi]	MAX. ALLOWED BACK PRESSURE [bar] / [psi]	DEFLATED PLUG		PRODUCT WEIGHT [kg] / [lbs]	EYE BOLT M THREAD	INFLATION VALVE THREAD SIZE
		MIN. DIA. [mm] / [inch]	MAX. DIA. [mm] / [inch]			DIAMETER [mm] / [inch]	LENGTH [mm] / [inch]			
60887	100-150 / 4"-6"	100 / 4"	150 / 6"	6 / 87	3 / 44	92 / 3.6"	535 / 21"	1.2 / 3	6	R 1/4"
60907	150-200 / 6"-8"	150 / 6"	200 / 8"	6 / 87	3 / 44	142 / 5.6"	575 / 23"	2 / 5	8	R 1/4"
60908	200-300 / 8"-12"	200 / 8"	300 / 12"	6 / 87	3 / 44	192 / 7.6"	635 / 25"	3.2 / 7	8	R 1/4"
60909	350-500 / 14"-20"	350 / 14"	500 / 20"	6 / 87	3 / 44	322 / 12.7"	865 / 34"	8.7 / 20	8	R 1/4"
60924	500-600 / 20"-24"	500 / 20"	600 / 24"	6 / 87	3 / 44	472 / 18.6"	1185 / 47"	18 / 40	10	R 1/4"

### PLUGY HP 12 bar (174 psi) - BLOCKING PLUGS

PART NUMBER	NOMINAL SIZE	SIZE USAGE RANGE		REQUIRED INFLATION PRESSURE [bar] / [psi]	MAX. ALLOWED BACK PRESSURE [bar] / [psi]	DEFLATED PLUG		PRODUCT WEIGHT [kg] / [lbs]	EYE BOLT M THREAD	INFLATION VALVE THREAD SIZE
		MIN. DIA. [mm] / [inch]	MAX. DIA. [mm] / [inch]			DIAMETER [mm] / [inch]	LENGTH [mm] / [inch]			
518561	100-125 / 4"-5"	100 / 4"	125 / 5"	12 / 174	10 / 145	92 / 3.6"	540 / 21"	1.5 / 4	6	R 1/4"
518562	150 / 6"	150 / 6"	150 / 6"	12 / 174	10 / 145	142 / 5.6"	580 / 23"	2.7 / 6	8	R 1/4"
518563	200-250 / 8"-10"	200 / 8"	250 / 10"	12 / 174	10 / 145	192 / 7.6"	640 / 25"	4.3 / 10	8	R 1/4"
518564	300-350 / 12"-14"	300 / 12"	350 / 14"	12 / 174	10 / 145	272 / 10.7"	670 / 27"	8 / 18	8	R 1/4"
518565	400 / 16"	400 / 16"	400 / 16"	12 / 174	10 / 145	322 / 12.7"	870 / 34"	11.5 / 26	10	R 1/4"
518566	500 / 20"	500 / 20"	500 / 20"	12 / 174	10 / 145	472 / 18.6"	1190 / 47"	24.1 / 53	10	R 1/4"

### PLUGY HP 30 bar (435 psi) - BLOCKING PLUGS

PART NUMBER	NOMINAL SIZE	SIZE USAGE RANGE		REQUIRED INFLATION PRESSURE [bar] / [psi]	MAX. ALLOWED BACK PRESSURE [bar] / [psi]	DEFLATED PLUG		RUBBER SLEEVE LENGTH [mm] / [inch]	PRODUCT WEIGHT [kg] / [lbs]
		MIN. DIA. [mm] / [inch]	MAX. DIA. [mm] / [inch]			DIAMETER [mm] / [inch]	LENGTH [mm] / [inch]		
538625	55-75 / 2"-3"	55 / 2"	75 / 3"	30 / 435	16 / 232	54 / 2.1"	615 / 24"	400 / 16"	3 / 7
533837	75-100 / 3"-4"	75 / 3"	100 / 4"	30 / 435	16 / 232	73 / 2.9"	600 / 24"	400 / 16"	5 / 11
533838	100-150 / 4"-6"	100 / 4"	150 / 6"	30 / 435	16 / 232	88 / 3.5"	614 / 24"	400 / 16"	6.7 / 15
533839	150-200 / 6"-8"	150 / 6"	200 / 8"	30 / 435	16 / 232	122 / 4.8"	621 / 24"	400 / 16"	13 / 29

### PLUGSY HP 30 bar (435 psi) - BYPASS PLUGS

PART NUMBER	NOMINAL SIZE	SIZE USAGE RANGE		REQUIRED INFLATION PRESSURE [bar] / [psi]	MAX. ALLOWED BACK PRESSURE [bar] / [psi]	FLOW THROUGH [mm] / [inch]	BYPASS THREAD [inch]	RUBBER SLEEVE LENGTH [mm] / [inch]	PRODUCT WEIGHT [kg] / [lbs]
		MIN. DIA. [mm] / [inch]	MAX. DIA. [mm] / [inch]						
537553	55-75 / 2"-3"	55 / 2"	75 / 3"	30 / 435	16 / 232	10 / 0.4"	3/8	400 / 16"	3 / 7
537661	75-100 / 3"-4"	75 / 3"	100 / 4"	30 / 435	16 / 232	15 / 0.6"	1/2	400 / 16"	4.8 / 11
537323	100-150 / 4"-6"	100 / 4"	150 / 6"	30 / 435	16 / 232	20 / 0.8"	3/4	400 / 16"	7 / 15
537672	150-200 / 6"-8"	150 / 6"	200 / 8"	30 / 435	16 / 232	25 / 1"	1	400 / 16"	13 / 29

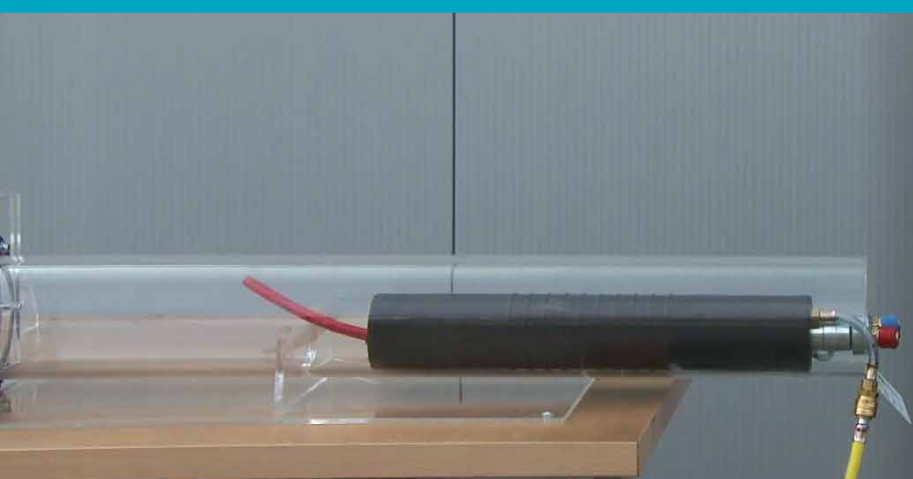

SAVA offers the equipment for testing according to EN 1610. The BS EN 1610 covers the construction and related testing of drains and sewers that are laid underground and/or operate under pressure. It is suitable for drains and sewers installed in the trenches, under the embankments or above ground.

Air test according to EN 1610

Water test according to EN 1610

AIR TEST CONCEPT

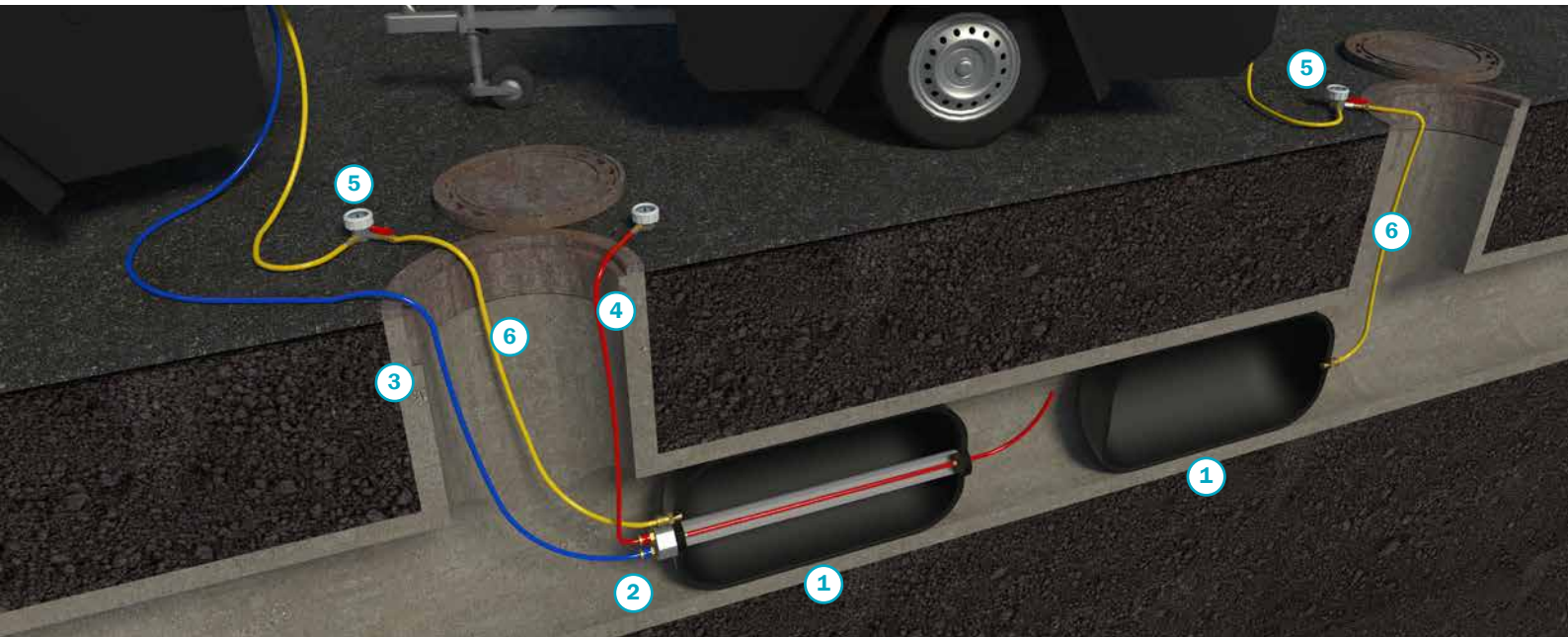

DIMENSIONS		1 PLUGS	2 ADAPTERS	3 INFLATION HOSES FOR FILLING THE PIPE	4 MEASURING HOSE	5 CONTROLLERS	6 INFLATION HOSES FOR PLUGS
<b>FOR SMALLER PLUGS</b>							
from	up to						
S6	S6-8	1 × PLUGY 1 × PLUGSY	1 × 60449	1 × 76684	1 × 78070	2 × 60010	2 × 78905
S8	S12		1 × 60450	1 × 76684	1 × 78070	2 × 60010	2 × 78905
<b>FOR LARGER PLUGS [mm] / [inch]</b>							
from	up to						
100-200 / 4"-8"	150-300 / 6"-12"	1 × PLUGY 1 × PLUGSY	1 × 60449	1 × 76684	1 × 78070	2 × 60310	2 × 76686
200-400 / 8"-16"	500-800 / 20"-32"		1 × 60450	1 × 60452	1 × 78070	2 × 60310	2 × 76686
500-1000 / 20"-40"			1 × 60450	1 × 60452	1 × 78070	2 × 74609	2 × 76686
600-1200 / 24"-48"			1 × 60443	1 × 60452	1 × 78070	2 × 74609	2 × 76686
750-1500 / 30"-60"	800-1800 / 32"-72"		1 × 60443	1 × 60452	1 × 78070	2 × 74653	2 × 76686

**AIR TEST EQUIPMENT**



**ADAPTER R1", 2× QUICK ACTION COUPLING**  
60449



**ADAPTER R2", WITH GEKA COUPLING, AND QUICK ACTION COUPLING**  
60450



**ADAPTER R4", WITH GEKA COUPLING, AND QUICK ACTION COUPLING**  
60443



**INFLATION HOSE 8 mm I.D. WITH QUICK ACTION COUPLING TO FILL THE PIPE**  
5 m (16.4')  
76684



**INFLATION HOSE 19 mm I.D. WITH GEKA COUPLING TO FILL THE PIPE**  
5 m (16.4'),  
60452



**MEASURING HOSE WITH NIPPLE AND GAUGE, RED**  
0-0.6 bar (0-9 psi), 10 m (33')  
78070



**SINGLE FITTING CONTROLLER,**  
2.5 bar (36 psi) 60310  
1.5 bar (22 psi) 74609  
1.0 bar (15 psi) 74653



**INFLATION HOSE, YELLOW**  
10 m (33')  
76686



**HAND OPERATED PUMP**  
60010



**INFLATION HOSE, TRANSPARENT,**  
5 m (16.4'),  
78905

**WATER TEST CONCEPT**



DIMENSIONS		1 PLUGS	2 ADAPTERS	3 STORZ COUPLING	4 FLOATING BLEEDERS	5 CONTROLLERS	6 INFLATION HOSES FOR PLUGS
<b>FOR SMALLER PLUGS</b>							
from	up to						
S6	S6-8	2 × PLUGSY	1 × 60407	1 × 60380	1 × 60446	2 × 60010	2 × 78905
S8	S12		1 × 60412	1 × 60388	1 × 60448	2 × 60010	2 × 78905
<b>FOR LARGER PLUGS [mm] / [inch]</b>							
from	up to						
<b>100-200 / 4"-8"</b>	<b>150-300 / 6"-12"</b>	2 × PLUGSY	1 × 60407	1 × 60380	1 × 60446	2 × 60310	2 × 76686
<b>200-400 / 8"-16"</b>	<b>500-800 / 20"-32"</b>		1 × 60412	1 × 60388	1 × 60448	2 × 60310	2 × 76686
<b>500-1000 / 20"-40"</b>			1 × 60412	1 × 60388	1 × 60448	2 × 74609	2 × 76686
<b>600-1200 / 24"-48"</b>			1 × 60438	1 × 60428	1 × 60439	2 × 74609	2 × 76686
<b>750-1500 / 30"-60"</b>	<b>800-1800 / 32"-72"</b>		1 × 60438	1 × 60428	1 × 60439	2 × 74653	2 × 76686

## WATER TEST EQUIPMENT



**ADAPTER, STORZ D  
TEST AND MEASURING HOSE,  
6 m (19.7')  
60407**



**ADAPTER, STORZ C  
TEST AND MEASURING HOSE,  
6 m (19.7')  
60412**



**ADAPTER, STORZ A  
TEST AND MEASURING HOSE,  
6 m (19.7')  
60438**



**STORZ COUPLING  
D 60380  
C 60388  
A 60428**



**FLOATING BLEEDER  
HOSE R 1"  
60446**



**FLOATING BLEEDER  
HOSE R 2"  
60448**



**FLOATING BLEEDER  
HOSE R 4"  
60439**



**INFLATION HOSE,  
YELLOW  
10 m (33')  
76686**



**SINGLE FITTING CONTROLLER,  
2.5 bar (36 psi) 60310  
1.5 bar (22 psi) 74609  
1.0 bar (15 psi) 74653**



**HAND PUMP  
0.8 kg (1.8 lbs)  
60010**



**INFLATION HOSE,  
TRANSPARENT  
5 m (16.4')  
78905**



# 1. 17.

# HOUSE CONNECTION TEST SET

SAVA house connection test set is suitable for tightness test in house connections, piping and drains with water or air according to the DIN EN 1610 standard. It is simple to use and facilitates effective work from one inlet opening with a simultaneous inflation of both plugs. The distance between the testing plugs can quickly be adjusted, as connecting hoses are of different lengths. The product is well known for its simple use, reliability and low air requirement.

Suitable for EN 1610 testing

Simultaneous inflation of both plugs

Simple handling and use

High-quality materials



XL SET (COMBINED SET)

- Simultaneous inflation of both plugs
- Small/short/compact bypass plugs with hoses of various colours

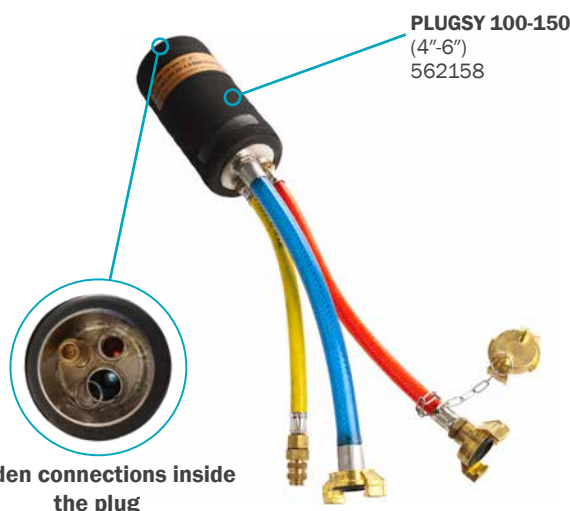

## ADVANTAGES

- Extremely light and flexible sealing plug
- Handy and simple venting floater
- Extremely flexible push rods
- Small, compact, lightweight, impact-resistant and weatherproof carrying case

### HOUSE CONNECTION TEST SET- PLUGY, PLUGSY

PART NUMBER	TYPE	SIZE USAGE RANGE		REQUIRED INFLATION PRESSURE [bar] / [psi]	MAX. ALLOWED BACK PRESSURE [bar] / [psi]	SIZE OF DEFLATED PLUG		INSERTION OPENING [mm] / [inch]	PRODUCT WEIGHT [kg] / [lbs]
		MIN. DIA. [mm] / [inch]	MAX. DIA. [mm] / [inch]			DIAMETER [mm] / [inch]	LENGTH [mm] / [inch]		
562158	Plugsy 100-150 / 4"-6"	100 / 4"	150 / 6"	2.5 / 36	0.2 / 3	80 / 3"	160 / 6"	100 / 4"	1.5 / 3.3
564063	Plugy 100-150 / 4"-6"	100 / 4"	150 / 6"	2.5 / 36	1 / 15	98 / 4"	420 / 17"	100 / 4"	0.6 / 1.3
562159	Plugsy 150-210 / 6"-8"	150 / 4"	210 / 6"	2.5 / 36	0.2 / 3	120 / 5"	180 / 7"	150 / 6"	2.9 / 6.4
564064	Plugy 150-210 / 6"-8"	150 / 4"	210 / 6"	2.5 / 36	1 / 15	140 / 6"	510 / 20"	150 / 6"	0.8 / 1.8

## PROPOSED HOUSE CONNECTION TEST SETS

PART NUMBER	DESCRIPTION	QUANTITY		
		XL SET (COMBINED SET)	M SET	S SET
562158	Plugsy 100-150 (4"-6")	1	1	
564063	Plugsy 100-150 (4"-6")	1	1	
562159	Plugsy 150-210 (6"-8")	1		1
564064	Plugsy 150-210 (6"-8")	1		1
564061	Spring hose connector	1	1	1
562150	GEKA T piece	1	1	1
562151	GEKA ball valve	1	1	1
562152	Water measuring hose fi 13, 5 m (16.4')	1	1	1
562153	Air inflation hose fi 8 mm, 3 m (9.8')	1	1	1
562157	Holding rope fi 3 mm, 10 m (33')	1	1	1
563381	Controller 2.5 bar (36 psi)	1	1	1
563535	Venting floater	1	1	1
547164	Push rod HC-TIP 21KS L=0.5 m (1.6')	2	1	1
547165	Push rod HC-TIP 21KS L=1.0 m (3.3')	1	1	1
547166	Push rod HC-TIP 21KS L=2.0 m (6.6')	4	1	1
566556	Push rod carrying sleeve	1	1	1
567429	Con. Element for testing with air	1	1	1
566529	Carrying case - small		1	1
562160	Carrying case - large	1		

## ACCESSORIES

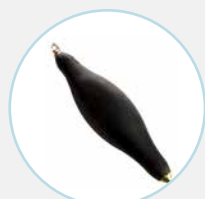

**PLUGSY 100-150**  
(4-6")  
564063



**PLUGSY 150-210**  
(6-8")  
564064

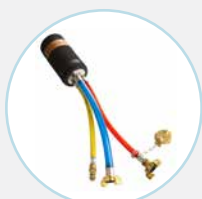

**PLUGSY 100-150**  
(4-6")  
562158



**PLUGSY 150-210**  
(6-8")  
562159

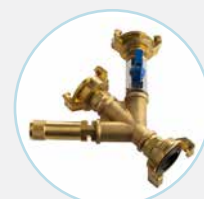

**CON. ELEMENT FOR TESTING WITH AIR**  
567429



**CARRYING CASE - LARGER**  
562160



**CARRYING CASE - SMALLER**  
566529



**HOLDING ROPE**  
FI 3 mm, 10 m (33')  
562157



**VENTING FLOATER**  
563535



**SPRING HOSE CONNECTOR**  
564061

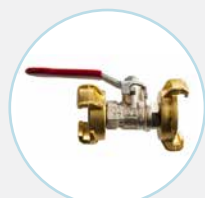

**GEKA BALL VALVE**  
562151



**3x GEKA T PIECE**  
562150



**WATER MEASURING HOSE**  
FI 13 mm, 5 m (16.4')  
562152



**AIR INFLATION HOSE**  
FI 8 mm, 3 m (9.8')  
562153

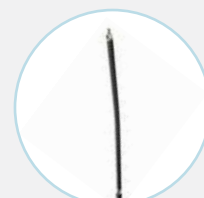

**PUSH ROD HC-TYPE**  
21 KS, L=0.5 m (1.6')  
547164



**CONTROLLER**  
2.5 bar (36 psi)  
563381



**PROTECTION PIPE FOR PUSH RODS**  
565089



**PUSH ROD HC-TYPE**  
21 KS, L=1 m (3.3')  
547165

**PUSH ROD HC-TYPE**  
21 KS, L=2 m (6.6')  
547166



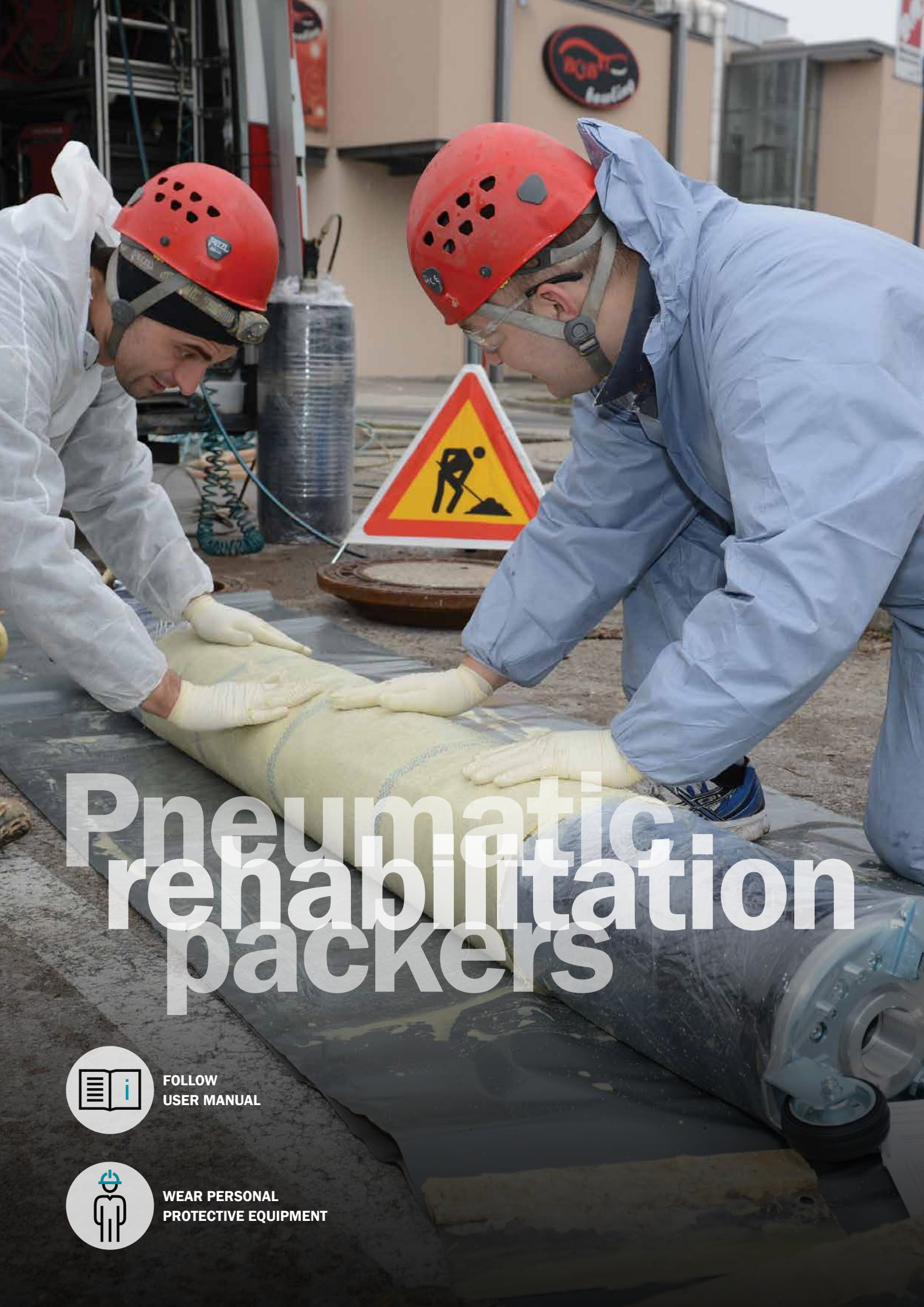

# Pneumatic rehabilitation packers

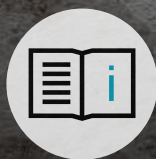

FOLLOW  
USER MANUAL



WEAR PERSONAL  
PROTECTIVE EQUIPMENT



**SAVA LATERAL PACKERS** are suitable for repairs of pipes of smaller diameters, especially in house connection installations. These packers are rounded on both ends in order to simplify handling and insertion. They are equipped with quick action couplings.

Replaceable rubber sleeve	Highly flexible	Non-corrodive metal parts	Lightweight and flexible
---------------------------	-----------------	---------------------------	--------------------------

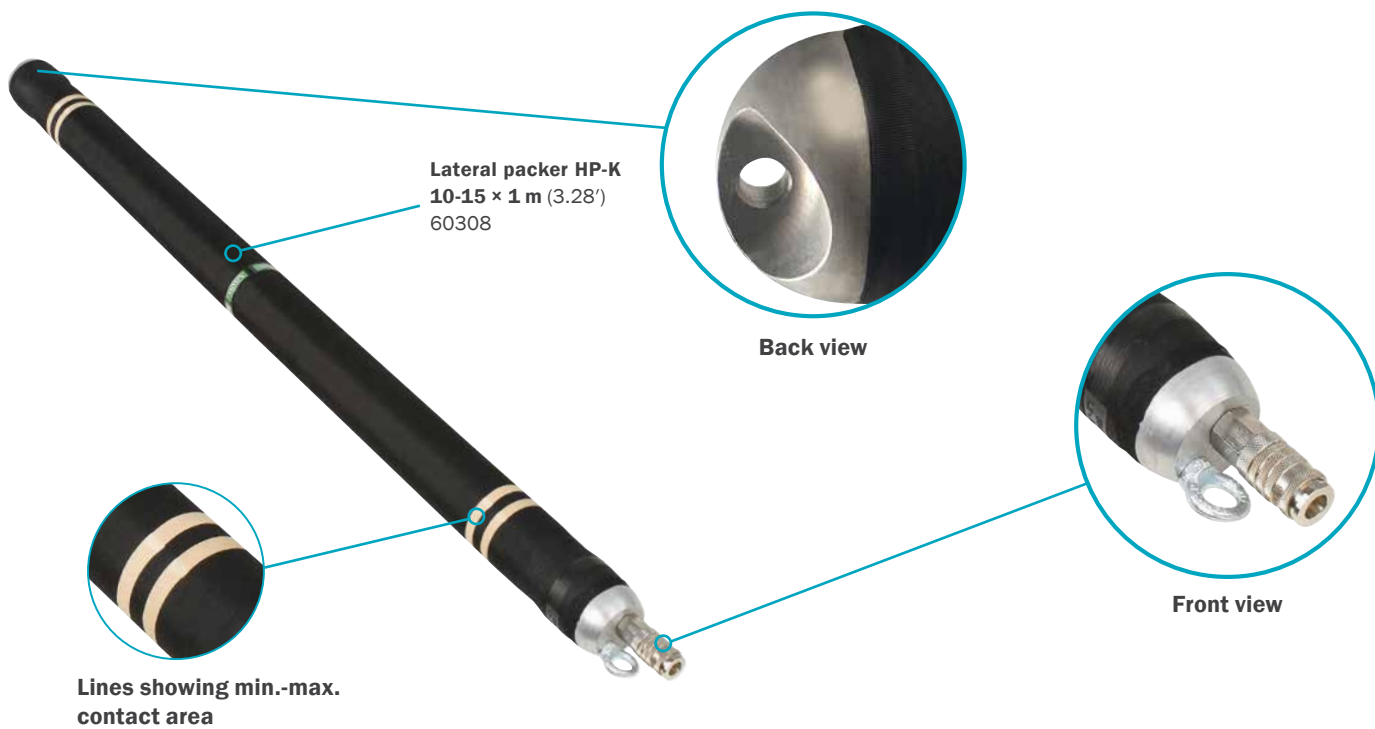

### ACCESSORIES



**SINGLE FITTING CONTROLLER,**  
0.9 kg (2 lbs)  
3.0 bar (44 psi) 537048  
2.5 bar (36 psi) 60310



**PUSH RODS**  
1.5 m (4.9'), 0.3 kg (0.7 lbs) 60491



**INFLATION HOSE,**  
10 m (33'), 1.2 kg (2.6 lbs)  
**RED** 74268  
**BLUE** 71248  
**YELLOW** 76686



**POLY LIFT INFLATION HOSE,**  
5 m (16.4'), 1.9 kg (4.2 lbs) 60957  
10 m (33'), 2.4 kg (5.3 lbs) 60958



## 2. 1.

## LATERAL PACKERS HP-K

### LATERAL PACKERS

PART NUMBER	NOMINAL SIZE	SIZE USAGE RANGE		REQUIRED INFLATION PRESSURE [bar] / [psi]	PRODUCT WEIGHT [kg] / [lbs]	RUBBER BODY LENGTH [mm] / [inch]	DEFLATED PACKER	
		MIN. DIA. [mm] / [inch]	MAX. DIA. [mm] / [inch]				DIAMETER [mm] / [inch]	LENGTH [mm] / [inch]
529897	3.5-5 × 0.7 m / 1.4"-2" × 2.3'	35 / 1.4"	50 / 2"	3 / 44	0.4 / 1	700 / 28"	26 / 1"	765 / 30"
530785	3.5-5 × 1 m / 1.4"-2" × 3.3'	35 / 1.4"	50 / 2"	3 / 44	0.5 / 1	1000 / 40"	26 / 1"	1065 / 42"
530786	3.5-5 × 1.5 m / 1.4"-2" × 4.9'	35 / 1.4"	50 / 2"	3 / 44	0.7 / 2	1500 / 59"	26 / 1"	1565 / 62"
530787	3.5-5 × 2 m / 1.4"-2" × 6.6'	35 / 1.4"	50 / 2"	3 / 44	0.8 / 2	2000 / 79"	26 / 1"	2065 / 81"
538491	3.5-5 × 3 m / 1.4"-2" × 9.8'	35 / 1.4"	50 / 2"	3 / 44	1.1 / 2	3000 / 118"	26 / 1"	3065 / 121"
542187	5-7.5 × 0.7 m / 2"-3" × 2.3'	50 / 2"	75 / 3"	3 / 44	0.6 / 1	700 / 28"	30 / 1.2"	765 / 30"
281246	5-7.5 × 1 m / 2"-3" × 3.3'	50 / 2"	75 / 3"	3 / 44	0.7 / 2	1000 / 40"	30 / 1.2"	1065 / 42"
543422	5-7.5 × 1.5 m / 2"-3" × 4.9'	50 / 2"	75 / 3"	3 / 44	0.8 / 2	1500 / 59"	30 / 1.2"	1565 / 62"
543423	5-7.5 × 2 m / 2"-3" × 6.6'	50 / 2"	75 / 3"	3 / 44	1.1 / 2	2000 / 79"	30 / 1.2"	2065 / 81"
543431	5-7.5 × 3 m / 2"-3" × 9.8'	50 / 2"	75 / 3"	3 / 44	1.4 / 3	3000 / 118"	30 / 1.2"	3065 / 121"
60052	7-10 × 0.6 m / 3"-4" × 2'	70 / 3"	100 / 4"	2.5 / 36	0.6 / 1	600 / 24"	45 / 1.8"	720 / 28"
60053	7-10 × 1 m / 3"-4" × 3.3'	70 / 3"	100 / 4"	2.5 / 36	0.8 / 2	1000 / 40"	45 / 1.8"	1120 / 44"
60059	7-10 × 1.5 m / 3"-4" × 4.9'	70 / 3"	100 / 4"	2.5 / 36	1.1 / 2	1500 / 59"	45 / 1.8"	1620 / 64"
60060	7-10 × 2 m / 3"-4" × 6.6'	70 / 3"	100 / 4"	2.5 / 36	1.4 / 3	2000 / 79"	45 / 1.8"	2120 / 84"
559830	7-10 × 2.5 m / 3"-4" × 8.2'	70 / 3"	100 / 4"	2.5 / 36	1.6 / 4	2500 / 98"	45 / 1.8"	2620 / 103"
60061	7-10 × 3 m / 3"-4" × 9.8'	70 / 3"	100 / 4"	2.5 / 36	1.9 / 4	3000 / 118"	45 / 1.8"	3120 / 123"
60069	7-10 × 4 m / 3"-4" × 3.1'	70 / 3"	100 / 4"	2.5 / 36	2.4 / 5	4000 / 158"	45 / 1.8"	4120 / 162"
60081	7-10 × 5 m / 3"-4" × 16.4'	70 / 3"	100 / 4"	2.5 / 36	2.8 / 6	4900 / 193"	45 / 1.8"	5020 / 198"
60307	10-15 × 0.6 m / 4"-6" × 2'	100 / 4"	150 / 6"	2.5 / 36	1.1 / 2	600 / 24"	65 / 2.6"	720 / 28"
60308	10-15 × 1 m / 4"-6" × 3.3'	100 / 4"	150 / 6"	2.5 / 36	1.5 / 3	1000 / 40"	65 / 2.6"	1120 / 44"
60309	10-15 × 1.5 m / 4"-6" × 4.9'	100 / 4"	150 / 6"	2.5 / 36	1.9 / 4	1500 / 59"	65 / 2.6"	1620 / 64"
60311	10-15 × 2 m / 4"-6" × 6.6'	100 / 4"	150 / 6"	2.5 / 36	2.4 / 5	2000 / 79"	65 / 2.6"	2120 / 84"
60224	10-15 × 2.5 m / 4"-6" × 8.2'	100 / 4"	150 / 6"	2.5 / 36	2.8 / 6	2500 / 98"	65 / 2.6"	2620 / 103"
60461	10-15 × 3 m / 4"-6" × 9.8'	100 / 4"	150 / 6"	2.5 / 36	3.2 / 7	3000 / 118"	65 / 2.6"	3120 / 123"
60492	10-15 × 4 m / 4"-6" × 13.1'	100 / 4"	150 / 6"	2.5 / 36	4 / 9	4000 / 158"	65 / 2.6"	4120 / 162"
60298	10-15 × 5 m / 4"-6" × 16.4'	100 / 4"	150 / 6"	2.5 / 36	5.4 / 12	4900 / 193"	65 / 2.6"	5020 / 198"
60314	15-20 × 0.6 m / 6"-8" × 2'	150 / 6"	200 / 8"	2.5 / 36	1.9 / 4	600 / 24"	85 / 3.3"	720 / 28"
60330	15-20 × 1 m / 6"-8" × 3.3'	150 / 6"	200 / 8"	2.5 / 36	2.5 / 6	1000 / 40"	85 / 3.3"	1120 / 44"
60331	15-20 × 1.5 m / 6"-8" × 4.9'	150 / 6"	200 / 8"	2.5 / 36	3.1 / 7	1500 / 59"	85 / 3.3"	1620 / 64"
60343	15-20 × 2 m / 6"-8" × 6.6'	150 / 6"	200 / 8"	2.5 / 36	3.8 / 8	2000 / 79"	85 / 3.3"	2120 / 84"
60516	15-20 × 3 m / 6"-8" × 9.8'	150 / 6"	200 / 8"	2.5 / 36	5 / 11	3000 / 118"	85 / 3.3"	3120 / 123"
60955	15-20 × 4 m / 6"-8" × 13.1'	150 / 6"	200 / 8"	2.5 / 36	6.3 / 14	4000 / 158"	85 / 3.3"	4120 / 162"
60005	15-20 × 5 m / 6"-8" × 16.4'	150 / 6"	200 / 8"	2.5 / 36	8.6 / 19	4900 / 193"	85 / 3.3"	5020 / 198"
569503	15-25 × 0.6 m / 6"-10" × 2'	150 / 6"	250 / 10"	2.5 / 36	4.1 / 9	600 / 24"	105 / 4.1"	670 / 26"
569504	15-25 × 1 m / 6"-10" × 3.3'	150 / 6"	250 / 10"	2.5 / 36	4.8 / 10.6	1000 / 40"	105 / 4.1"	1070 / 42"
282122	15-25 × 1.5 m / 6"-10" × 4.9'	150 / 6"	250 / 10"	2.5 / 36	5.7 / 12.5	1500 / 59"	105 / 4.1"	1570 / 62"
569505	15-25 × 2 m / 6"-10" × 6.6'	150 / 6"	250 / 10"	2.5 / 36	6.5 / 14.3	2000 / 79"	105 / 4.1"	2070 / 81"
569506	15-25 × 3 m / 6"-10" × 9.8'	150 / 6"	250 / 10"	2.5 / 36	8.2 / 18.0	3000 / 118"	105 / 4.1"	3070 / 121"
569507	15-25 × 4 m / 6"-10" × 13.1'	150 / 6"	250 / 10"	2.5 / 36	9.8 / 21.6	4000 / 158"	105 / 4.1"	4070 / 160"
569508	15-25 × 5 m / 6"-10" × 16.4'	150 / 6"	250 / 10"	2.5 / 36	11.5 / 25.3	5000 / 193"	105 / 4.1"	5070 / 200"



TYPE 26 - SAFETY

# MEDUSA PACKERS

2. 2.



The ends of Medusa packers are made from special and extremely flexible soft rubber, which simplifies handling of the packer in narrow spaces. Since the packer end can be pushed closer to the pipe edge, T-connection pipe repairs are more efficient.

- Fully flexible soft rubber end
- Sealing of blind sewage lines
- Eyebolt on soft rubber end available on request
- Superb handling properties

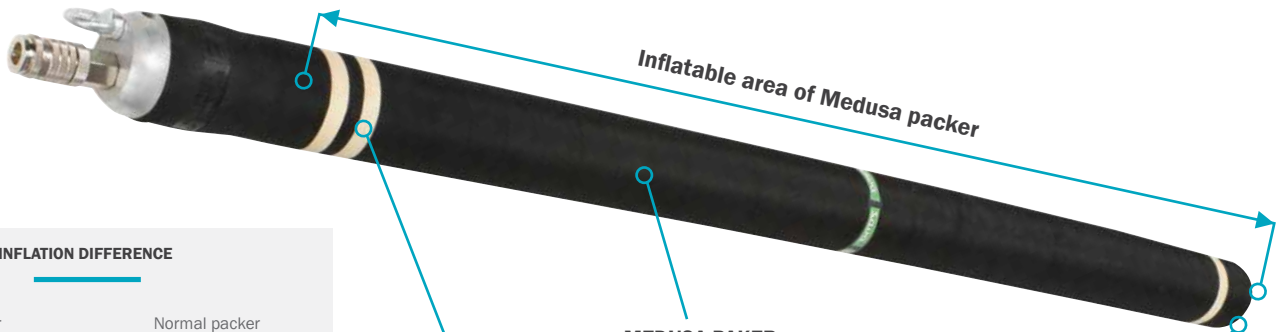

Inflatable area of Medusa packer

**MEDUSA PAKER**  
10-15 x 1 m (3.3')  
569458

### INFLATION DIFFERENCE

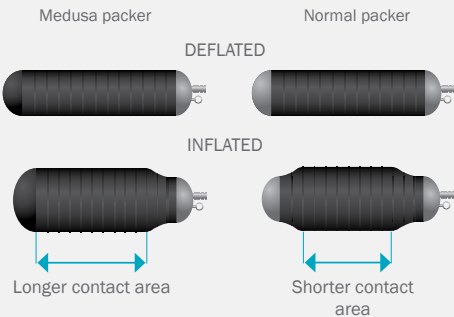

Lines showing min.-max. contact area



Soft rubber end

## ACCESSORIES



**SINGLE FITTING CONTROLLER,**  
0.9 kg (2 lbs)  
3.0 bar (44 psi) 537048  
2.5 bar (36 psi) 60310



**PUSH RODS**  
1.5 m (4.9'), 0.3 kg (0.7 lbs) 60491



**INFLATION HOSE,**  
10 m (33'), 1.2 kg (2.6 lbs)  
RED 74268  
BLUE 71248  
YELLOW 76686



**POLY LIFT INFLATION HOSE,**  
5 m (16.4'), 1.9 kg (4.2 lbs) 60957  
10 m (33'), 2.4 kg (5.3 lbs) 60958

## 2. 2.

# MEDUSA PACKERS

### ADVANTAGES OF MEDUSA PACKER

Better reach of rehabilitation area

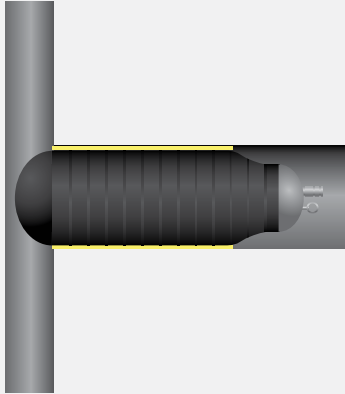

Medusa packer

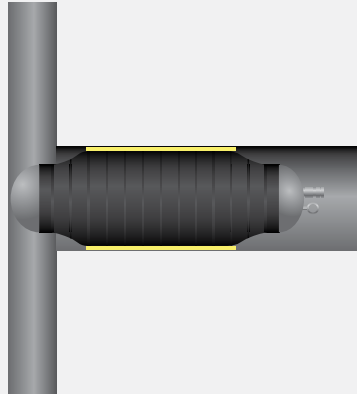

Normal packer

Sealing of blind holes



Easier reach through collapsed pipes

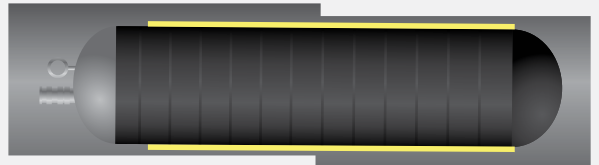

\* Yellow colour indicates the curing area

### MEDUSA PACKERS

PART NUMBER	NOMINAL SIZE	SIZE USAGE RANGE		REQUIRED INFLATION PRESSURE [bar] / [psi]	PRODUCT WEIGHT [kg] / [lbs]	RUBBER BODY LENGTH [mm] / [inch]	DEFLATED PACKER	
		MIN. DIA. [mm] / [inch]	MAX. DIA. [mm] / [inch]				DIAMETER [mm] / [inch]	LENGTH [mm] / [inch]
592613	5-7.5 × 0.6 m / 2'-3" × 2'	50 / 2"	75 / 3"	2.5 / 36	0.8 / 1.8	600 / 24"	32 / 1.3"	640 / 25"
569452	7-10 × 0.6 m / 3'-4" × 2'	70 / 3"	100 / 4"	2.5 / 36	1 / 2	600 / 24"	45 / 1.8"	640 / 25"
569453	7-10 × 1 m / 3'-4" × 3.3'	70 / 3"	100 / 4"	2.5 / 36	1.6 / 4	1000 / 40"	45 / 1.8"	1040 / 41"
569454	7-10 × 1.5 m / 3'-4" × 4.9'	70 / 3"	100 / 4"	2.5 / 36	2 / 4	1500 / 59"	45 / 1.8"	1540 / 61"
569456	7-10 × 2 m / 3'-4" × 6.6'	70 / 3"	100 / 4"	2.5 / 36	2.7 / 6	2000 / 79"	45 / 1.8"	2040 / 80"
569457	10-15 × 0.6 m / 4'-6" × 2'	100 / 4"	150 / 6"	2.5 / 36	2.2 / 5	600 / 24"	65 / 2.6"	640 / 25"
569458	10-15 × 1 m / 4'-6" × 3.3'	100 / 4"	150 / 6"	2.5 / 36	3.1 / 7	1000 / 40"	65 / 2.6"	1040 / 41"
569459	10-15 × 1.5 m / 4'-6" × 4.9'	100 / 4"	150 / 6"	2.5 / 36	4 / 9	1500 / 59"	65 / 2.6"	1540 / 61"
569460	10-15 × 2 m / 4'-6" × 6.6'	100 / 4"	150 / 6"	2.5 / 36	5.5 / 12	2000 / 79"	65 / 2.6"	2040 / 80"
569461	15-20 × 0.6 m / 6'-8" × 2'	150 / 6"	200 / 8"	2.5 / 36	2.4 / 5	600 / 24"	85 / 3.3"	640 / 25"
569462	15-20 × 1 m / 6'-8" × 3.3'	150 / 6"	200 / 8"	2.5 / 36	3.3 / 7	1000 / 40"	85 / 3.3"	1040 / 41"
569463	15-20 × 1.5 m / 6'-8" × 4.9'	150 / 6"	200 / 8"	2.5 / 36	4.4 / 10	1500 / 59"	85 / 3.3"	1540 / 61"
569464	15-20 × 2 m / 6'-8" × 6.6'	150 / 6"	200 / 8"	2.5 / 36	5.8 / 13	2000 / 79"	85 / 3.3"	2040 / 80"



The unique construction and excellent choice of rubber compounds for SAVA packers HP-T90° allow efficient repairs of 45°, 60° and 90° pipeline bends. The rigid parts of SAVA packers HP-90° are made as short as possible in order to ease insertion and pulling the packers through pipeline bends.

Two unique designs

Suitable for pipe repairs at angles 45° - 90°

Special inflation process

Push hose inside the packer

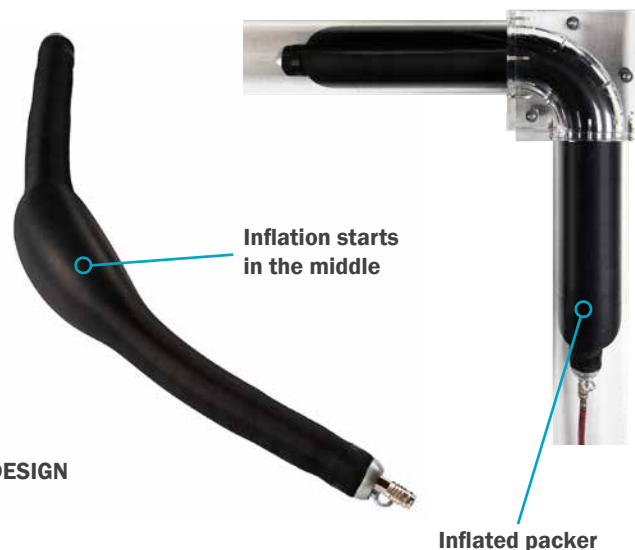

ACCESSORIES



**SINGLE FITTING CONTROLLER,**  
 0.9 kg (2 lbs)  
 3.0 bar (44 psi) 537048  
 2.5 bar (36 psi) 60310



**PUSH RODS**  
 1.5 m (4.9'), 0.3 kg (0.7 lbs)  
 60491



**INFLATION HOSE,**  
 10 m (33'), 1.2 kg (2.6 lbs)  
 RED 74268  
 BLUE 71248  
 YELLOW 76686



**POLY LIFT INFLATION HOSE,**  
 5 m (16.4'), 1.9 kg (4.2 lbs) 60957  
 10 m (33'), 2.4 kg (5.3 lbs) 60958



## 2. 3.

## 90° PACKERS HP-T90°

### PACKERS HP - T90°

PART NUMBER	NOMINAL SIZE	SIZE USAGE RANGE		REQUIRED INFLATION PRESSURE [bar] / [psi]	PRODUCT WEIGHT [kg] / [lbs]	RUBBER BODY LENGTH [mm] / [inch]	DEFLATED PACKER	
		MIN. DIA. [mm] / [inch]	MAX. DIA. [mm] / [inch]				DIAMETER [mm] / [inch]	LENGTH [mm] / [inch]
281856	35-50 × 0.7 m / 1.4"-2" × 2.3'	35 / 1.4"	50 / 2"	3 / 44	0.8 / 1.8"	700 / 28"	26 / 1"	750 / 30"
558628	50-70 × 0.7 m / 2"-2.8" × 2.3'	50 / 2"	70 / 2.8"	2 / 29	0.7 / 1.5"	600 / 24"	30 / 1.2"	750 / 30"
281774	70-80 × 0.6 m / 2.8"-3" × 2'	70 / 2.8"	80 / 3"	2 / 29	0.8 / 1.8"	550 / 22"	45 / 1.8"	650 / 26"
525957	70-80 × 1 m / 2.8"-3" × 3.3'	70 / 2.8"	80 / 3"	2 / 29	0.9 / 2"	1000 / 40"	45 / 1.8"	1120 / 44"
525958	70-80 × 1.5 m / 2.8"-3" × 4.9'	70 / 2.8"	80 / 3"	2 / 29	1.2 / 3"	1500 / 59"	45 / 1.8"	1620 / 64"
578140	80-100 × 1 m / 3"-4" × 3'	80 / 3"	100 / 4"	2 / 29	2.5 / 5.5	1000 / 40"	65 / 2.6"	1120 / 44"
580365	80-100 × 1.5 m / 3"-4" × 4.9'	80 / 3"	100 / 4"	2 / 29	3.6 / 7.9"	1500 / 59"	65 / 2.6"	1620 / 64"
525960	100-125 × 1 m / 4"-5" × 3.3'	100 / 4"	125 / 5"	2 / 29	2 / 4"	1000 / 40"	65 / 2.6"	1120 / 44"
525961	100-125 × 1.5 m / 4"-5" × 4.9'	100 / 4"	125 / 5"	2 / 29	2.8 / 6"	1500 / 59"	65 / 2.6"	1620 / 64"
525963	150-165 × 1 m / 6"-6.5" × 3.3'	150 / 6"	165 / 6.5"	2 / 29	3.2 / 7"	1000 / 40"	85 / 3.3"	1120 / 44"
525964	150-165 × 1.5 m / 6"-6.5" × 4.9'	150 / 6"	165 / 6.5"	2 / 29	4.1 / 9"	1500 / 59"	85 / 3.3"	1620 / 64"
525959	180-205 × 1 m / 7"-8" × 3.3'	180 / 7"	205 / 8"	2 / 29	5.6 / 12"	1000 / 40"	105 / 4.1"	1120 / 44"
525962	180-205 × 1.5 m / 7"-8" × 4.9'	180 / 7"	205 / 8"	2 / 29	6.1 / 13"	1500 / 59"	105 / 4.1"	1620 / 64"
281628	200-250 × 1 m / 8"-10" × 3.3'	200 / 8"	250 / 10"	2 / 29	8.4 / 19"	1000 / 40"	130 / 5.1"	1120 / 44"
560617	200-250 × 1.5 m / 8"-10" × 4.9'	200 / 8"	250 / 10"	2 / 29	10.5 / 23"	1500 / 59"	130 / 5.1"	1620 / 64"
282151	250-350 × 1.5 m / 10"-14" × 4.9'	250 / 10"	350 / 14"	2 / 29	13.6 / 30"	1500 / 59"	140 / 5.5"	1620 / 64"

### PACKERS HP - T90° R

PART NUMBER	NOMINAL SIZE	SIZE USAGE RANGE		REQUIRED INFLATION PRESSURE [bar] / [psi]	PRODUCT WEIGHT [kg] / [lbs]	RUBBER BODY LENGTH [mm] / [inch]	DEFLATED PACKER	
		MIN. DIA. [mm] / [inch]	MAX. DIA. [mm] / [inch]				DIAMETER [mm] / [inch]	LENGTH [mm] / [inch]
579553	70-80 × 0.6 m / 2.8"-3" × 2'	70 / 2.8"	80 / 3"	2 / 29	0.8 / 1.8	600 / 24"	45 / 1.8"	630 / 25"
282182	70-80 × 1 m / 2.8"-3" × 3.3'	70 / 2.8"	80 / 3"	2 / 29	0.9 / 2	1000 / 40"	45 / 1.8"	1100 / 43"
574995	70-80 × 1.5 m / 2.8"-3" × 4.9'	70 / 2.8"	80 / 3"	2 / 29	1.2 / 3	1500 / 59"	45 / 1.8"	1600 / 63"
588405	80-100 × 1 m / 3"-4" × 3.3'	80 / 3"	100 / 4"	2 / 29	2.3 / 5.1	1000 / 40"	65 / 2.6"	1100 / 43"
588406	80-100 × 1.5 m / 3"-4" × 4.9'	80 / 3"	100 / 4"	2 / 29	2.7 / 5.9	1500 / 59"	65 / 2.6"	1600 / 63"
574211	100-125 × 1 m / 4"-5" × 3.3'	100 / 4"	125 / 5"	2 / 29	2 / 4	1000 / 40"	65 / 2.6"	1100 / 43"
578251	100-125 × 1.5 m / 4"-5" × 4.9'	100 / 4"	125 / 5"	2 / 29	2.8 / 6	1500 / 59"	65 / 2.6"	1600 / 63"
574212	150-165 × 1 m / 6"-6.5" × 3.8'	150 / 6"	165 / 6.5"	2 / 29	3.2 / 7	1000 / 40"	85 / 3.3"	1100 / 43"
578254	150-165 × 1.5 m / 6"-6.5" × 4.9'	150 / 6"	165 / 6.5"	2 / 29	4.1 / 9	1500 / 59"	85 / 3.3"	1600 / 63"
574213	180-205 × 1 m / 7"-8" × 3.3'	180 / 7"	205 / 8"	1.5 / 22	5.6 / 12	1000 / 40"	105 / 4.1"	1100 / 43"
578258	180-205 × 1.5 m / 7"-8" × 4.9'	180 / 7"	205 / 8"	1.5 / 22	6.1 / 13	1500 / 59"	105 / 4.1"	1600 / 63"



**SAVA FLEXIBLE PACKERS** are suitable for patch repairs ranging from 1 up to 5 meters (3.3' - 16.4'). They are equipped with a bypass and wheel system that allows positioning along the pipeline. They can easily bend and fit through the manholes.

**Equipped with wheels**

**Highly flexible**

**Replaceable rubber sleeve**

**Long lifetime**



## ACCESSORIES



**SINGLE FITTING CONTROLLER,**  
0.9 kg (2 lbs)  
2.5 bar (36 psi) 60310  
2.0 bar (29 psi) 565643  
1.5 bar (22 psi) 74609  
1.0 bar (15 psi) 74653



**PUSH RODS**  
1.5 m (4.9'), 0.3 kg (0.7 lbs) 60491



**INFLATION HOSE,**  
10 m (33'), 1.2 kg (2.6 lbs)  
**RED** 74268  
**BLUE** 71248  
**YELLOW** 76686



**POLY LIFT INFLATION HOSE,**  
5 m (16.4'), 1.9 kg (4.2 lbs) 60957  
10 m (33'), 2.4 kg (5.3 lbs) 60958

## 2. 4.

## FLEXIBLE PACKERS

### FLEXIBLE PACKERS

PART NUMBER	NOMINAL SIZE	SIZE USAGE RANGE		REQUIRED INFLATION PRESSURE [bar] / [psi]	PRODUCT WEIGHT [kg] / [lbs]	RUBBER BODY LENGTH [mm] / [inch]	DEFLATED PACKER		BYPASS DIAMETER (FEMALE)
		MIN. DIA. [mm] / [inch]	MAX. DIA. [mm] / [inch]				TOTAL LENGTH [mm] / [inch]	DIAMETER [mm] / [inch]	
78214	10-15 × 1 m / 4"-6" × 3.3'	100 / 4"	150 / 6"	2.5 / 36	2.1 / 4.6	1000 / 39"	1080 / 43"	65 / 2.6"	NA
549589	10-15 × 1.5 m / 4"-6" × 4.9'	100 / 4"	150 / 6"	2.5 / 36	2.5 / 5.5	1500 / 59"	1580 / 62"	65 / 2.6"	NA
78266	10-15 × 2 m / 4"-6" × 6.6'	100 / 4"	150 / 6"	2.5 / 36	2.8 / 6.2	1900 / 75"	1980 / 78"	65 / 2.6"	NA
78218	10-15 × 2.5 m / 4"-6" × 8.2'	100 / 4"	150 / 6"	2.5 / 36	3.3 / 7.3	2500 / 98"	2580 / 102"	65 / 2.6"	NA
78231	10-15 × 3 m / 4"-6" × 9.8'	100 / 4"	150 / 6"	2.5 / 36	4.2 / 9.3	3000 / 118"	3080 / 121"	65 / 2.6"	NA
78244	10-15 × 4 m / 4"-6" × 13.1'	100 / 4"	150 / 6"	2.5 / 36	5 / 11	4000 / 158"	4080 / 161"	65 / 2.6"	NA
78283	10-15 × 5 m / 4"-6" × 16.4'	100 / 4"	150 / 6"	2.5 / 36	6 / 13	4900 / 193"	4980 / 196"	65 / 2.6"	NA
77240	15-25 × 1 m / 6"-10" × 3.3'	150 / 6"	250 / 10"	2 / 29	8 / 18	1000 / 39"	1210 / 48"	112 / 4.4"	2"
60853	15-25 × 1.5 m / 6"-10" × 4.9'	150 / 6"	250 / 10"	2 / 29	9.5 / 21	1500 / 59"	1710 / 67"	112 / 4.4"	2"
77614	15-25 × 2 m / 6"-10" × 6.6'	150 / 6"	250 / 10"	2 / 29	11 / 24	1900 / 75"	2110 / 83"	112 / 4.4"	2"
60846	15-25 × 2.5 m / 6"-10" × 8.2'	150 / 6"	250 / 10"	2 / 29	12.7 / 28	2500 / 98"	2710 / 107"	112 / 4.4"	2"
60497	15-25 × 3 m / 6"-10" × 9.8'	150 / 6"	250 / 10"	2 / 29	14.5 / 32	3000 / 118"	3210 / 126"	112 / 4.4"	2"
516143	15-25 × 3.5 / 6"-10" × 11.5'	150 / 6"	250 / 10"	2 / 29	15.8 / 35	3500 / 138"	3710 / 146"	112 / 4.4"	2"
60556	15-25 × 4 m / 6"-10" × 13.1'	150 / 6"	250 / 10"	2 / 29	17.4 / 38	4000 / 158"	4210 / 166"	112 / 4.4"	2"
60585	15-25 × 5 m / 6"-10" × 16.4'	150 / 6"	250 / 10"	2 / 29	21.4 / 47	4900 / 193"	5110 / 201"	112 / 4.4"	2"
569518	20-30 × 1 m / 8"-12" × 3.3'	200 / 8"	300 / 12"	1.5 / 22	11.3 / 25	1000 / 39"	1210 / 48"	145 / 5.7"	2"
569519	20-30 × 2 m / 8"-12" × 6.6'	200 / 8"	300 / 12"	1.5 / 22	13.3 / 29	2000 / 79"	2210 / 87"	145 / 5.7"	2"
569520	20-30 × 2.5 m / 8"-12" × 8.2'	200 / 8"	300 / 12"	1.5 / 22	14.3 / 32	2500 / 98"	2610 / 103"	145 / 5.7"	2"
569521	20-30 × 3 m / 8"-12" × 9.8'	200 / 8"	300 / 12"	1.5 / 22	15.2 / 34	3000 / 118"	3210 / 126"	145 / 5.7"	2"
569522	20-30 × 4 m / 8"-12" × 13.1'	200 / 8"	300 / 12"	1.5 / 22	17.2 / 38	4000 / 158"	4210 / 166"	145 / 5.7"	2"
569523	20-30 × 5 m / 8"-12" × 16.4'	200 / 8"	300 / 12"	1.5 / 22	19.1 / 42	4900 / 193"	5110 / 201"	145 / 5.7"	2"
77241	30-40 × 1 m / 12"-16" × 3.3'	300 / 12"	400 / 16"	1.5 / 22	19.2 / 42	1120 / 44"	1370 / 54"	210 / 8.3"	3"
514320	30-40 × 1.5 m / 12"-16" × 4.9'	300 / 12"	400 / 16"	1.5 / 22	21.6 / 48	1620 / 64"	1840 / 72"	210 / 8.3"	3"
77680	30-40 × 2 m / 12"-16" × 6.6'	300 / 12"	400 / 16"	1.5 / 22	25 / 55	2120 / 84"	2340 / 92"	210 / 8.3"	3"
60525	30-40 × 2.5 m / 12"-16" × 8.2'	300 / 12"	400 / 16"	1.5 / 22	30 / 66	2620 / 103"	2810 / 111"	210 / 8.3"	3"
60587	30-40 × 3 m / 12"-16" × 9.8'	300 / 12"	400 / 16"	1.5 / 22	33 / 73	3120 / 123"	3300 / 130"	210 / 8.3"	3"
60593	30-40 × 4 m / 12"-16" × 13.1'	300 / 12"	400 / 16"	1.5 / 22	41.5 / 92	4120 / 162"	4280 / 169"	210 / 8.3"	3"
60594	30-40 × 5 m / 12"-16" × 16.4'	300 / 12"	400 / 16"	1.5 / 22	47 / 104	4880 / 192"	5060 / 199"	210 / 8.3"	3"
77242	45-60 × 1 m / 18"-24" × 3.3'	450 / 18"	600 / 24"	1.2 / 17	34.5 / 76	1120 / 44"	1350 / 53"	340 / 13.4"	3"
517034	45-60 × 1.5 m / 18"-24" × 4.9'	450 / 18"	600 / 24"	1.2 / 17	36.6 / 81	1630 / 64"	1860 / 73"	340 / 13.4"	3"
78718	45-60 × 2 m / 18"-24" × 6.6'	450 / 18"	600 / 24"	1.2 / 17	41.6 / 92	2020 / 80"	2240 / 88"	340 / 13.4"	3"
60526	45-60 × 2.5 m / 18"-24" × 8.2'	450 / 188"	600 / 24"	1.2 / 17	50 / 110	2650 / 104"	2870 / 113"	340 / 13.4"	3"
78860	45-60 × 3 m / 18"-24" × 9.8'	450 / 18"	600 / 24"	1.2 / 17	53 / 117	3000 / 118"	3220 / 127"	340 / 13.4"	3"
65027	60-80 × 1.5 m / 24"-32" × 4.9'	600 / 24"	800 / 32"	1 / 15	46.8 / 103	1620 / 64"	1840 / 72"	400 / 15.7"	3"
60120	60-80 × 2 m / 24"-32" × 6.6'	600 / 24"	800 / 32"	1 / 15	52 / 115	2040 / 80"	2280 / 90"	400 / 15.7"	3"
60527	60-80 × 2.5 m / 24"-32" × 8.2'	600 / 24"	800 / 32"	1 / 15	61 / 135	2650 / 104"	2820 / 111"	400 / 15.7"	3"
60598	60-80 × 3 m / 24"-32" × 9.8'	600 / 24"	800 / 32"	1 / 15	65 / 143	2880 / 113"	3060 / 121"	400 / 15.7"	3"
78015	80-100 × 1.5 m / 32"-40" × 4.9'	800 / 32"	1000 / 40"	1 / 15	68.2 / 150	1540 / 61"	1780 / 70"	535 / 21.1"	4"
79186	100-120 × 2 m / 40"-48" × 6.6'	1000 / 40"	1200 / 48"	1 / 15	75 / 165	2000 / 79"	2240 / 88"	535 / 21.1"	4"



TYPE 26 - SAFETY

# LONG PACKERS

2. 5.



**SAVA LONG PACKERS** are suitable for repairs of pipes of diameters from 200 up to 800 mm (8"-32"). Long packers are available with or without a wheel system. They are perfect for experienced users when a bypass is not needed.

**Economical construction**

**Two different designs**

**Long lifetime**

**Extremely flexible**

### LONG PACKER DESIGN

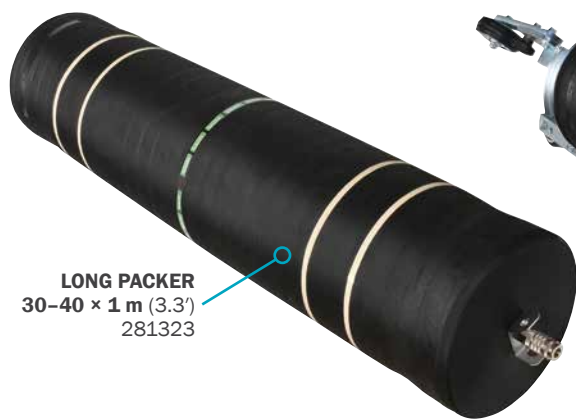

**LONG PACKER**  
30-40 × 1 m (3.3')  
281323

### LONG PACKER WITH WHEELS DESIGN

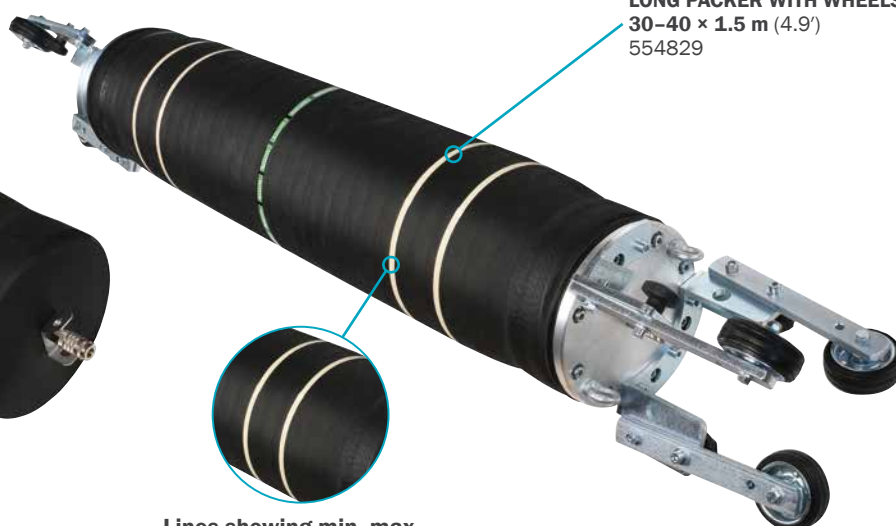

**LONG PACKER WITH WHEELS**  
30-40 × 1.5 m (4.9')  
554829

Lines showing min.-max. contact area

## ACCESSORIES



**SINGLE FITTING CONTROLLER,**  
0.9 kg (2 lbs)  
1.5 bar (22 psi) 74609  
1.0 bar (15 psi) 74653



**PUSH RODS**  
1.5 m (4.9'), 0.3 kg (0.7 lbs) 60491



**INFLATION HOSE,**  
10 m (33'), 1.2 kg (2.6 lbs)  
**RED** 74268  
**BLUE** 71248  
**YELLOW** 76686



**POLY LIFT INFLATION HOSE,**  
5 m (16.4'), 1.9 kg (4.2 lbs) 60957  
10 m (33'), 2.4 kg (5.3 lbs) 60958



## 2. 5.

## LONG PACKERS

### LONG PACKERS

PART NUMBER	NOMINAL SIZE	SIZE USAGE RANGE		REQUIRED INFLATION PRESSURE [bar] / [psi]	PRODUCT WEIGHT [kg] / [lbs]	RUBBER BODY LENGTH [mm] / [inch]	DEFLATED PACKER	
		MIN. DIA. [mm] / [inch]	MAX. DIA. [mm] / [inch]				DIAMETER [mm] / [inch]	LENGTH [mm] / [inch]
541996	20-30 × 1 m / 8"-12" × 3.3'	200 / 8"	300 / 12"	1.5 / 22	4.9 / 11	1000 / 39"	145 / 5.7"	1100 / 43"
78256	20-30 × 1.5 m / 8"-12" × 4.9'	200 / 8"	300 / 12"	1.5 / 22	5.7 / 13	1500 / 59"	145 / 5.7"	1600 / 63"
67042	20-30 × 2 m / 8"-12" × 6.6'	200 / 8"	300 / 12"	1.5 / 22	6.5 / 14	2000 / 79"	145 / 5.7"	2100 / 83"
78257	20-30 × 2.5 m / 8"-12" × 8.2'	200 / 8"	300 / 12"	1.5 / 22	8.5 / 19	2500 / 98"	145 / 5.7"	2600 / 102"
77386	20-30 × 3 m / 8"-12" × 9.8'	200 / 8"	300 / 12"	1.5 / 22	10.8 / 24	3000 / 118"	145 / 5.7"	3100 / 122"
78258	20-30 × 4 m / 8"-12" × 13.1'	200 / 8"	300 / 12"	1.5 / 22	13.6 / 30	4000 / 158"	145 / 5.7"	4100 / 161"
77237	20-30 × 5 m / 8"-12" × 16.4'	200 / 8"	300 / 12"	1.5 / 22	18.4 / 41	4900 / 193"	145 / 5.7"	5000 / 197"
281323	30-40 × 1 m / 12"-16" × 3.3'	300 / 12"	400 / 16"	1.5 / 22	7.7 / 17	1000 / 39"	245 / 9.6"	1100 / 43"
78259	30-40 × 1.5 m / 12"-16" × 4.9'	300 / 12"	400 / 16"	1.5 / 22	13 / 29	1500 / 59"	245 / 9.6"	1600 / 63"
77925	30-40 × 2 m / 12"-16" × 6.6'	300 / 12"	400 / 16"	1.5 / 22	15.5 / 34	2000 / 79"	245 / 9.6"	2100 / 83"
77926	30-40 × 2.5 m / 12"-16" × 8.2'	300 / 12"	400 / 16"	1.5 / 22	16.7 / 37	2500 / 98"	245 / 9.6"	2600 / 102"
78260	30-40 × 3 m / 12"-16" × 9.8'	300 / 12"	400 / 16"	1.5 / 22	20 / 44	3000 / 118"	245 / 9.6"	3100 / 122"
78261	30-40 × 4 m / 12"-16" × 13.1'	300 / 12"	400 / 16"	1.5 / 22	26.3 / 58	4000 / 158"	245 / 9.6"	4100 / 161"
78262	30-40 × 5 m / 12"-16" × 16.4'	300 / 12"	400 / 16"	1.5 / 22	33.4 / 74	4900 / 193"	245 / 9.6"	5000 / 197"
560468	40-50 × 1 m / 16"-20" × 3.3'	400 / 16"	500 / 20"	1 / 15	18.9 / 42	1000 / 39"	340 / 13.4"	1100 / 43"
78263	40-50 × 1.5 m / 16"-20" × 4.9'	400 / 16"	500 / 20"	1 / 15	24.5 / 54	1500 / 59"	340 / 13.4"	1650 / 65"
77553	40-50 × 2 m / 16"-20" × 6.6'	400 / 16"	500 / 20"	1 / 15	27.7 / 61	2000 / 79"	340 / 13.4"	2150 / 85"
77239	40-50 × 2.5 m / 16"-20" × 8.2'	400 / 16"	500 / 20"	1 / 15	28 / 62	2500 / 98"	340 / 13.4"	2650 / 104"
78264	40-50 × 3 m / 16"-20" × 9.8'	400 / 16"	500 / 20"	1 / 15	30.5 / 67	3000 / 118"	340 / 13.4"	3100 / 122"
78265	40-50 × 4 m / 16"-20" × 13.1'	400 / 16"	500 / 20"	1 / 15	33 / 73	4000 / 158"	340 / 13.4"	4150 / 163"
77238	40-50 × 5 m / 16"-20" × 16.4'	400 / 16"	500 / 20"	1 / 15	38 / 84	5000 / 197"	340 / 13.4"	5150 / 203"
60179	50-60 × 1.5 m / 20"-24" × 4.9'	500 / 20"	600 / 24"	0.8 / 12	30 / 66	1500 / 59"	405 / 15.9"	1650 / 65"
67040	50-60 × 2 m / 20"-24" × 6.6'	500 / 20"	600 / 24"	0.8 / 12	34 / 75	2000 / 79"	405 / 15.9"	2150 / 84"
60190	50-60 × 2.5 m / 20"-24" × 8.2'	500 / 20"	600 / 24"	0.8 / 12	37.8 / 83	2500 / 98"	405 / 15.9"	2650 / 104"
70072	50-60 × 3 m / 20"-24" × 9.8'	500 / 20"	600 / 24"	0.8 / 12	40.8 / 90	3000 / 118"	405 / 15.9"	3150 / 124"
70218	50-60 × 4 m / 20"-24" × 13.1'	500 / 20"	600 / 24"	0.8 / 12	46 / 101	4000 / 158"	405 / 15.9"	4150 / 163"
70066	50-60 × 5 m / 20"-24" × 16.4'	500 / 20"	600 / 24"	0.8 / 12	51.5 / 114	5000 / 197"	405 / 15.9"	5150 / 203"
60758	60-80 × 1.5 m / 24"-32" × 4.9'	600 / 24"	800 / 32"	0.6 / 9	47 / 104	1500 / 59"	535 / 21.1"	1650 / 65"
60759	60-80 × 2 m / 24"-32" × 6.6'	600 / 24"	800 / 32"	0.6 / 9	51 / 112	1900 / 75"	535 / 21.1"	2050 / 81"
60760	60-80 × 2.5 m / 24"-32" × 8.2'	600 / 24"	800 / 32"	0.6 / 9	54.5 / 120	2500 / 98"	535 / 21.1"	2650 / 104"
60761	60-80 × 3 m / 24"-32" × 9.8'	600 / 24"	800 / 32"	0.6 / 9	58 / 128	3000 / 118"	535 / 21.1"	3150 / 124"
60763	60-80 × 4 m / 24"-32" × 13.1'	600 / 24"	800 / 32"	0.6 / 9	66 / 146	4000 / 158"	535 / 21.1"	4150 / 163"
60764	60-80 × 5 m / 24"-32" × 16.4'	600 / 24"	800 / 32"	0.6 / 9	75 / 165	5000 / 197"	535 / 21.1"	5150 / 203"

### LONG PACKERS WITH WHEELS

PART NUMBER	NOMINAL SIZE	SIZE USAGE RANGE		REQUIRED INFLATION PRESSURE [bar] / [psi]	PRODUCT WEIGHT [kg] / [lbs]	RUBBER BODY LENGTH [mm] / [inch]	DEFLATED PACKER	
		MIN. DIA. [mm] / [inch]	MAX. DIA. [mm] / [inch]				DIAMETER [mm] / [inch]	LENGTH [mm] / [inch]
561419	20 - 30 × 1.5 m / 8"-12" × 4.9'	200 / 8"	300 / 12"	1.5 / 22	10.7 / 24	1500 / 59"	145 / 5.7"	1610 / 64"
569479	20 - 30 × 2 m / 8"-12" × 6.6'	200 / 8"	300 / 12"	1.5 / 22	11.7 / 26	2000 / 79"	145 / 5.7"	2110 / 83"
569480	20 - 30 × 2.5 m / 8"-12" × 8.2'	200 / 8"	300 / 12"	1.5 / 22	12.8 / 28	2500 / 98"	145 / 5.7"	2610 / 103"
569481	20 - 30 × 3 m / 8"-12" × 9.8'	200 / 8"	300 / 12"	1.5 / 22	14 / 31	3000 / 118"	145 / 5.7"	3110 / 122"
569482	20 - 30 × 4 m / 8"-12" × 13.1'	200 / 8"	300 / 12"	1.5 / 22	16 / 35	4000 / 158"	145 / 5.7"	4110 / 162"
569484	20 - 30 × 5 m / 8"-12" × 16.4'	200 / 8"	300 / 12"	1.5 / 22	18 / 40	5000 / 197"	145 / 5.7"	5110 / 201"
554829	30 - 40 × 1.5 m / 12"-16" × 4.9'	300 / 12"	400 / 16"	1.5 / 22	20 / 44	1500 / 59"	210 / 8.3"	1620 / 64"
563422	30 - 40 × 2 m / 12"-16" × 6.6'	300 / 12"	400 / 16"	1.5 / 22	23.6 / 52	2000 / 79"	210 / 8.3"	2120 / 83"
569485	30 - 40 × 2.5 m / 12"-16" × 8.2'	300 / 12"	400 / 16"	1.5 / 22	26 / 57	2500 / 98"	210 / 8.3"	2620 / 103"
569488	30 - 40 × 3 m / 12"-16" × 9.8'	300 / 12"	400 / 16"	1.5 / 22	30.5 / 67	3000 / 118"	210 / 8.3"	3120 / 123"
569489	30 - 40 × 4 m / 12"-16" × 13.1'	300 / 12"	400 / 16"	1.5 / 22	33.2 / 73	4000 / 158"	210 / 8.3"	4120 / 162"
569490	30 - 40 × 5 m / 12"-16" × 16.4'	300 / 12"	400 / 16"	1.5 / 22	38 / 84	5000 / 197"	210 / 8.3"	5120 / 202"
281493	40 - 50 × 1.5 m / 16"-20" × 4.9'	400 / 16"	500 / 20"	1 / 15	27 / 60	1500 / 59"	340 / 13.4"	1750 / 69"
569491	40 - 50 × 2 m / 16"-20" × 6.6'	400 / 16"	500 / 20"	1 / 15	30.2 / 67	2000 / 79"	340 / 13.4"	2250 / 89"
569492	40 - 50 × 2.5 m / 16"-20" × 8.2'	400 / 16"	500 / 20"	1 / 15	33.3 / 73	2500 / 98"	340 / 13.4"	2750 / 108"
569493	50 - 60 × 1.5 m / 20"-24" × 4.9'	500 / 20"	600 / 24"	0.8 / 12	40.4 / 89	1500 / 59"	400 / 16"	1760 / 69"
554830	50 - 60 × 2 m / 20"-24" × 6.6'	500 / 20"	600 / 24"	0.8 / 12	44.5 / 98	2000 / 79"	400 / 16"	2260 / 89"
569494	50 - 60 × 2.5 m / 20"-24" × 8.2'	500 / 20"	600 / 24"	0.8 / 12	48.2 / 106	2500 / 98"	400 / 16"	2760 / 109"
563790	60 - 80 × 1.5 m / 24"-32" × 4.9'	600 / 24"	800 / 32"	0.6 / 9	60 / 132	1500 / 59"	535 / 21.1"	1800 / 71"
569495	60 - 80 × 2 m / 24"-32" × 6.6'	600 / 24"	800 / 32"	0.6 / 9	65.5 / 144	2000 / 79"	535 / 21.1"	2300 / 91"

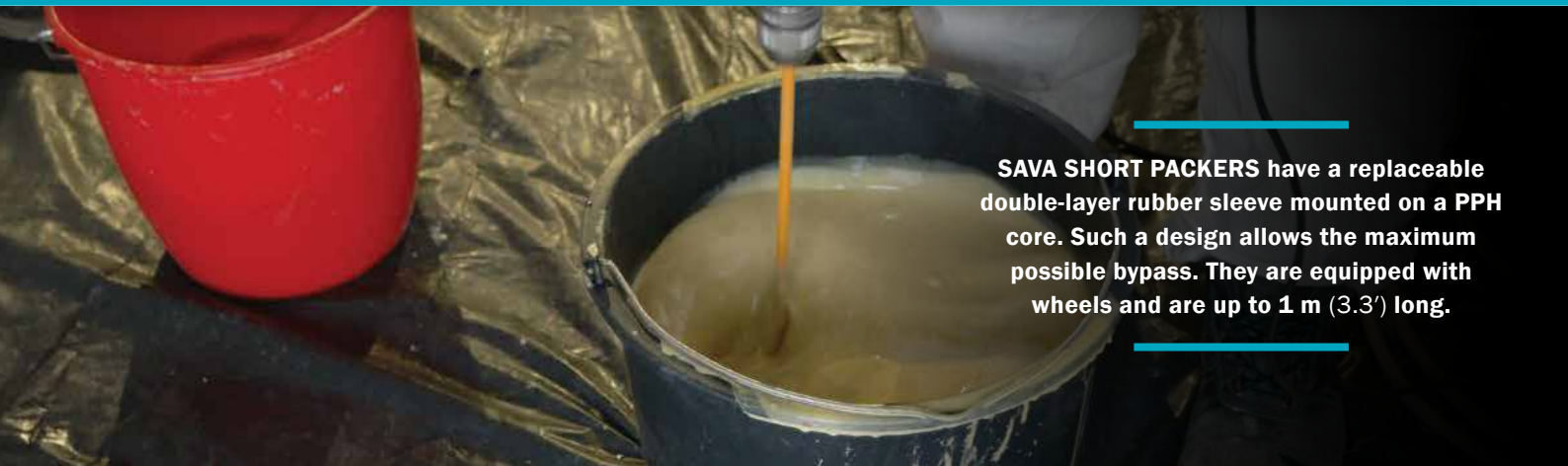

**SAVA SHORT PACKERS** have a replaceable double-layer rubber sleeve mounted on a PPH core. Such a design allows the maximum possible bypass. They are equipped with wheels and are up to 1 m (3.3') long.

Large bypass

Short construction

Double-layer rubber sleeve

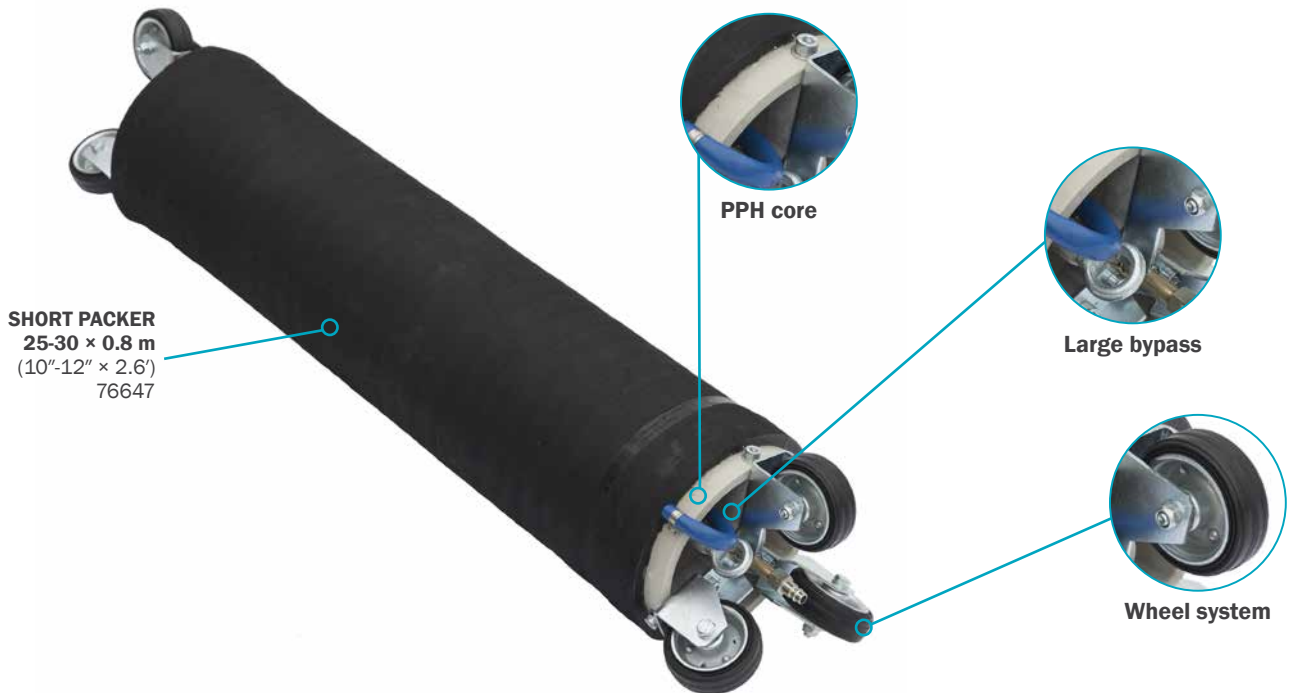

### SHORT PACKERS

PART NUMBER	NOMINAL SIZE	SIZE USAGE RANGE		REQUIRED INFLATION PRESSURE [bar] / [psi]	PRODUCT WEIGHT [kg] / [lbs]	RUBBER BODY LENGTH [mm] / [inch]	DEFLATED PACKER		BYPASS DIAMETER [mm] / [inch]
		MIN. DIA. [mm] / [inch]	MAX. DIA. [mm] / [inch]				DIAMETER [mm] / [inch]	LENGTH [mm] / [inch]	
76646	15-20 × 0.8 m / 6"-8" × 2.6'	150 / 6"	200 / 8"	2 / 29	6.3 / 14	800 / 32"	115 / 4.5"	960 / 38"	80 / 3"
76647	25-30 × 0.8 m / 10"-12" × 2.6'	250 / 10"	300 / 12"	2 / 29	12.8 / 28	800 / 32"	205 / 8.1"	1010 / 40"	160 / 6"
76821	30-35 × 0.8 m / 12"-14" × 2.6'	300 / 12"	350 / 14"	1.5 / 22	17.2 / 38	800 / 32"	250 / 9.8"	1010 / 40"	200 / 8"
76648	35-40 × 0.8 m / 14"-16" × 2.6'	350 / 14"	400 / 16"	1.5 / 22	19.1 / 42	800 / 32"	305 / 12"	1010 / 40"	260 / 10"
76649	45-50 × 0.8 m / 18"-20" × 2.6'	450 / 18"	500 / 20"	1.5 / 22	29.7 / 66	800 / 32"	380 / 15"	1010 / 40"	325 / 13"
78247	60-70 × 0.97 m / 24"-28" × 3.2'	600 / 24"	700 / 28"	1 / 15	50.2 / 111	970 / 38"	465 / 18.3"	1180 / 47"	390 / 15"

**SAVA T PACKERS** are intended for repairs of connections between the main and the lateral pipes. They exploit the advantages of flexible packer's design and are additionally equipped with a special inflation port in the middle section. This allows mounting of a specially designed hat, which is inflated independently of the main packer.

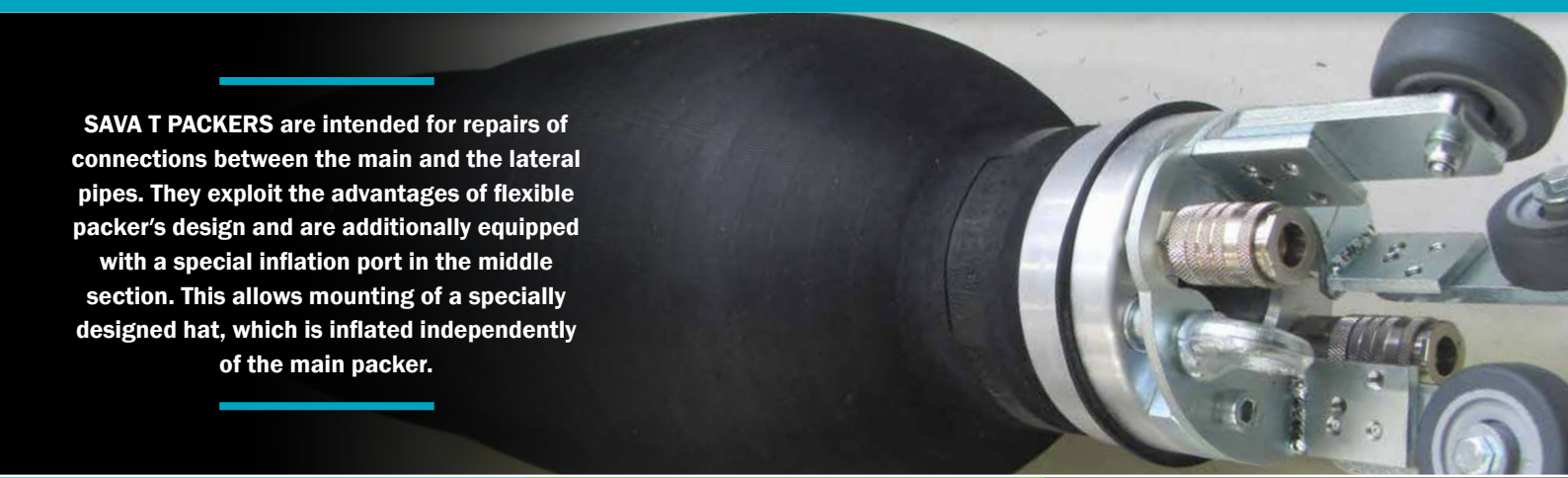

Replaceable hat	Independent inflation of the hat	Flexible design
-----------------	----------------------------------	-----------------

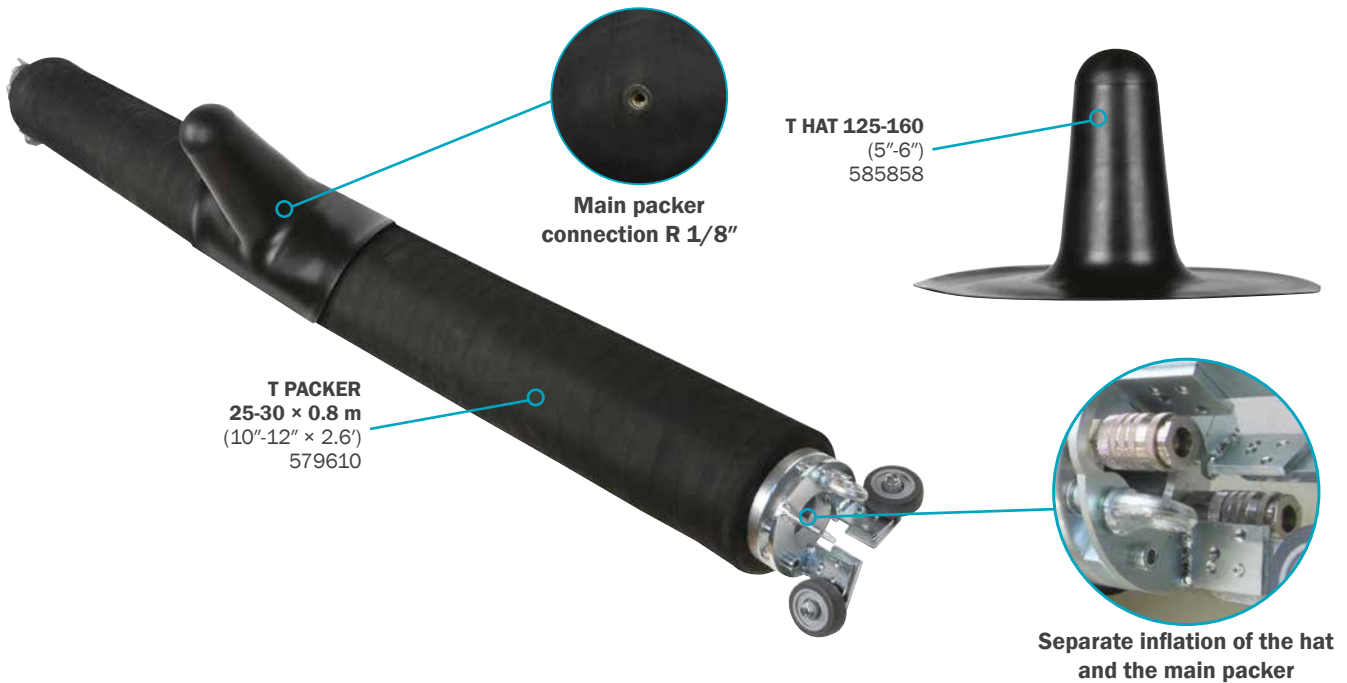

**MAIN T PACKERS**

PART NUMBER	NOMINAL SIZE	SIZE USAGE RANGE		REQUIRED INFLATION PRESSURE [bar] / [psi]	PRODUCT WEIGHT [kg] / [lbs]	RUBBER BODY LENGTH [mm] / [inch]	DEFLATED PACKER		BYPASS DIAMETER
		MIN. DIA. [mm] / [inch]	MAX. DIA. [mm] / [inch]				DIAMETER [mm] / [inch]	LENGTH [mm] / [inch]	
579609	20-25 × 0.8 m / 8"-10" × 2.6'	200 / 8"	250 / 10"	2 / 29	9 / 20	800 / 32"	112 / 4.4"	950 / 37"	2"
579610	25-30 × 0.8 m / 10"-12" × 2.6'	250 / 10"	300 / 12"	2 / 29	10 / 22	800 / 32"	145 / 5.7"	1000 / 40"	2"
579611	30-40 × 0.8 m / 12"-16" × 2.6'	300 / 12"	400 / 16"	2 / 29	18 / 40	800 / 32"	210 / 8.3"	1000 / 40"	3"

**T HATS**

PART NUMBER	NOMINAL SIZE	DIAMETER OF THE HAT		SIZE USAGE RANGE		REQUIRED INFLATION PRESSURE [bar] / [psi]	PRODUCT WEIGHT [kg] / [lbs]	INFLATION VALVE
		BOTTOM DIA. [mm] / [inch]	HAT HEIGHT [mm] / [inch]	MIN. DIA. [mm] / [inch]	MAX. DIA. [mm] / [inch]			THREAD SIZE
590982	80-100 / 3"-4"	120 / 4.7"	140 / 5.5"	80 / 3"	100 / 4"	1.5 / 22	1.3 / 2.9	M6
585857	100-125 / 4"-5"	320 / 12.6"	190 / 7.5"	100 / 4"	125 / 5"	1.4 / 20	0.84 / 1.9	M6
585858	125-160 / 5"-6"	340 / 13.4"	210 / 8.3"	125 / 5"	160 / 6"	1.3 / 19	1.25 / 2.8	M6
585860	160-250 / 6"-10"	390 / 15.4"	220 / 8.7"	160 / 6"	250 / 10"	1.2 / 17	1.8 / 4	M6



SAVA ULTRA FLEX ADVANCED PACKERS are suitable for repairs of pipes of diameters ranging from 100 – 500 mm (4"-20"). They are made from highly stretchable and flexible rubber, which allows a wider usage range with a single packer. They are suitable for patch repairs up to a size from 1 m to 5 m (3.3'-16.4').

Special high-elastic rubber

Elasticity exceeds 300 %

Extremely flexible

Wider usage range



UFAP PACKERS

PART NUMBER	NOMINAL SIZE	SIZE USAGE RANGE		REQUIRED INFLATION PRESSURE [bar] / [psi]	PRODUCT WEIGHT [kg] / [lbs]	RUBBER BODY LENGTH [mm] / [inch]	DEFLATED PACKER	
		MIN. DIA. [mm] / [inch]	MAX. DIA. [mm] / [inch]				DIAMETER [mm] / [inch]	LENGTH [mm] / [inch]
590971	100 - 200 × 1 m / 4"-8" × 3.3'	100 / 4"	200 / 8"	2.0 / 29	1.9 / 4	1000 / 39"	55 / 2.2"	1120 / 44"
590972	100 - 200 × 1.5 m / 4"-8" × 4.9'	100 / 4"	200 / 8"	2.0 / 29	2.5 / 6	1500 / 59"	55 / 2.2"	1620 / 64"
590973	100 - 200 × 2 m / 4"-8" × 6.6'	100 / 4"	200 / 8"	2.0 / 29	3.1 / 7	2000 / 79"	55 / 2.2"	2120 / 84"
590974	100 - 200 × 3 m / 4"-8" × 9.8'	100 / 4"	200 / 8"	2.0 / 29	4.2 / 9	3000 / 118"	55 / 2.2"	3120 / 123"
590975	100 - 200 × 4 m / 4"-8" × 13.1'	100 / 4"	200 / 8"	2.0 / 29	5.3 / 12	4000 / 158"	55 / 2.2"	4120 / 162"
590976	100 - 200 × 5 m / 4"-8" × 16.4'	100 / 4"	200 / 8"	2.0 / 29	6.4 / 14	5000 / 197"	55 / 2.2"	5020 / 198"
590977	200 - 500 × 1.5 m / 8"-20" × 4.9'	200 / 8"	500 / 20"	1.5 / 22	11 / 24	1500 / 59"	160 / 6.3"	1600 / 63"
590978	200 - 500 × 2 m / 8"-20" × 6.6'	200 / 8"	500 / 20"	1.5 / 22	15.8 / 35	2000 / 79"	160 / 6.3"	2100 / 83"
590979	200 - 500 × 3 m / 8"-20" × 9.8'	200 / 8"	500 / 20"	1.5 / 22	19.9 / 44	3000 / 118"	160 / 6.3"	3100 / 122"
590980	200 - 500 × 4 m / 8"-20" × 13.1'	200 / 8"	500 / 20"	1.5 / 22	25.4 / 60	4000 / 158"	160 / 6.3"	4100 / 161"
590981	200 - 500 × 5 m / 8"-20" × 16.4'	200 / 8"	500 / 20"	1.5 / 22	30 / 66	4700 / 185"	160 / 6.3"	4800 / 189"

ACCESSORIES



**SINGLE FITTING CONTROLLER,**  
 0.9 kg (2 lbs)  
 2.0 bar (29 psi) 565643  
 1.5 bar (22 psi) 74609



**INFLATION HOSE,**  
 10 m (33'),  
 1.2 kg (2.6 lbs)  
**RED** 74268  
**BLUE** 71248  
**YELLOW** 76686



**POLY LIFT INFLATION HOSE,**  
 5 m (16.4'), 1.9 kg (4.2 lbs) 60957  
 10 m (33'), 2.4 kg (5.3 lbs) 60958



The image shows five Erlenmeyer flasks of various sizes and colors of liquid. In the background, a large flask contains a blue liquid. In the middle ground, a medium-sized flask contains a yellow liquid, and another medium-sized flask contains a green liquid. In the foreground, a small flask contains a dark blue liquid, and a small flask contains a red liquid. The flasks are arranged on a light-colored surface, and the text 'Table of resistance' is overlaid in white, bold font across the center of the image.

# Table of resistance

## RESISTANCE TO THE MEDIA



The SAVA pneumatic plugs are resistant to certain types of chemicals. In selecting either NR/BR, CR or NBR variants of pneumatic plugs, check the chemical resistance table for rubber materials or consult the manufacturer. The temperature of the media may not exceed 80 °C (176 °F).

Types of SAVA pneumatic plugs with regard to their resistance to chemicals

MARKINGS	NAME	OUTER LAYER COMPOSITION
Without marking	NR/BR pneumatic plugs	NR/BR rubber
●	CR pneumatic plugs	CR rubber
●	NBR pneumatic plugs	NBR rubber

The resistance classification table is in compliance with the standard ISO/TR 7620. The effect of the media on the product is classified as:

1 NEGLIGIBLE	2 LOW	3 MEDIUM	4 SIGNIFICANT
--------------	-------	----------	---------------

Table of resistance to the media

MEDIA	CONCENTRATION (%)	TEMPERATURE [°C] / [°F]	NR/BR	CR	NBR
Acetone		23 / 73.4	1	2	4
Acetylene			1	2	1
Ammonium hydroxide	10	23 / 73.4	1	1	1
	Conc.	23 / 73.4	1	1	2
Aniline		23 / 73.4	2	3	4
		100 / 212	4	4	4
Benzene		23 / 73.4	4	4	4
Boric acid	10	100 / 212	1	1	1
Brake fluid (vegetable)		50 / 122	1	1	4
Butanol		50 / 122	1	1	1
		100 / 212	4	3	1
Butyric acid				2	4
Calcium hydroxide		100 / 212	1	1	2
Calcium hypochlorite	15		4	2	3
Chloric acid	20	23 / 73.4		4	4
Ethanol		50 / 122	1	1	1
Ether		23 / 73.4	4	4	2
Formaldehyde	40	23 / 73.4	1	1	1
	40	70 / 158			4
Glycerine		100 / 212	1	1	1
Hexanol		23 / 73.4	1	2	2
Hydrogen peroxide	30	23 / 73.4	1	1	1
	90		4	4	4
Kerosene		70 / 158	4	3	1
Methanol		50 / 122	1	1	1
Methyl chloride			4	4	4
Milk		23 / 73.4	1	1	1
Oil 1 (ASTM No.1, ISO 1817)		100 / 212	4	1	1
Oil 2 (IRM 902, ISO 1817)		100 / 212	4	2	1
Oil 3 (IRM 903, ISO 1817)		100 / 212	4	4	1
Naphtha		23 / 73.4	4	4	1
Natural gas			3	1	1
Nitric acid (diluted)	10	50 / 122	2	3	2
Ozone (conc. 50 ppm)		40 / 104	4	2	4
Phenol		100 / 212	4	4	4
Phosphoric acid	60	50 / 122	2	2	3
Propanol		50 / 122	1	1	2
Sodium hydroxide	10	100 / 212	1	1	1
	25	100 / 212	1	1	4
Sodium hypochlorite	10	50 / 122	2	3	3
Sulphur hexafluoride				1	1
Sulphuric acid (VI)	10	100 / 212	1	1	3
	20	23 / 73.4	1	1	3
	25	100 / 212	1	1	4
	50	100 / 212	1	1	4
	60	100 / 212	3	4	4
	75	100 / 212	4	4	4
	96	23 / 73.4	4	4	4
Toluene		23 / 73.4	4	4	4





About us  
& warranty



## 1. GENERAL CONDITIONS

- 1.1. These warranty conditions apply as for Environmental protection and rescue products, manufactured by Trelleborg Slovenija, d.o.o. (hereinafter referred to as TBSLO), Product Area Environmental protection and rescue products (Products). If any provision of this warranty conditions would be contrary to any mandatory legal provisions in any particular jurisdiction, such provision shall apply to a maximum extent as provided for by such mandatory legal provisions.
- 1.2. Products which may be sold by TBSLO Product Area Environmental protection and rescue products but are not manufactured by it are not covered by this warranty and are sold exclusively with warranties, if any, by their original manufacturer.

## 2. MANAGEMENT OF THE PRODUCTS

- 2.1. In order to claim a remedy pursuant to this warranty, purchaser must conform to instructions for management of the Products, available at <http://www.savatech.eu/environmental-protection-and-rescue-manuals.html>

## 3. WARRANTY

- 3.1. TBSLO warrants to the purchaser that for the period of twelve (12) months as of delivery of the Products, such Products shall be free from defects in material and workmanship, subject to normal and management of the Products, including, among others, proper storage. For high pressure lifting bags, the warranty period amounts to thirty-six (36) months as of delivery.
- 3.2. This warranty shall be in lieu of any other warranties, express or implied, including, but not limited to, any warranty of merchantability of fitness for a particular purpose.

## 4. EXCLUSION OF WARRANTY

- 4.1. Warranty shall be excluded in cases where the Products have not been used for the ordinary purpose or have been subject to abnormal conditions such as, but not limited to misuse, mishandling (such as, but not limited to, cuts, tears, vandalism, fire, wilful destruction, improper installation and/or improper maintenance, misapplication), use of unauthorized components or attachments or if adjustments or repairs have been performed by anyone other than TBSLO or its authorized agents.
- 4.2. Warranty shall also be excluded and TBSLO shall not be held liable in case of force majeure circumstances, such as, but not limited to:
  - war or threat of war, sabotage, insurrection, riots or requisition;
  - all laws, restrictions, regulations, by-laws, prohibitions or any other measures by the governmental, parliamentary or local bodies;
  - import and export regulations or embargo;
  - strikes, lock-outs or other industrial measures or trade disputes (if including Manufacturer's employees or third party);
  - difficulties with supply of raw materials, work force, fuel, parts or machinery;
  - power blackout, break of machinery.
- 4.3. TBSLO shall not be held liable for any deficiencies in Products manufactured according to drawings, designs, project drafts and/or specifications provided by the purchaser.
- 4.4. Ordinary wear and tear are not covered by this warranty.

## 5. MAKING A WARRANTY CLAIM

- 5.1. Purchaser is obliged to take delivery of the Products and perform an ordinary inspection of the Product upon delivery.

5.2. Any claim by the purchaser with reference to the Products shall be deemed waived unless submitted in writing to TBSLO within the earlier of (I) eight days as of the discovery of the defect, or (II) twelve months as of the date of delivery of the Products or thirty-six (36) months as of delivery of high pressure lifting bags. Discovery of the defect is deemed to have occurred when a defect could have reasonably been detected by the purchaser.

5.3. Claim must at least contain the following data:

- part number,
- serial number,
- description of defect,

and must be substantiated by adequate evidence, such as pictures... Upon request, TBSLO must be allowed to inspect the Product.

5.4. To obtain performance under this warranty, any products suspected of having a manufacturing defect in materials or workmanship shall be returned freight prepaid for inspection to TBSLO, Product Area Environmental protection and rescue products, Škofjeloška c. 6, 4000 Kranj, Slovenia.

## 6. REMEDIES

- 6.1. TBSLO shall decide on a claim within forty-five days after receiving a complete documentation and Product pursuant to art 5.
- 6.2. Providing TBSLO acknowledges the claim as justified, it shall, at its discretion, either:
  - repair the Product,
  - replace those components of the Product which are defective,
  - replace the Product, if repair is not possible or reasonable,
  - reimburse the consideration for the Product or its components which are defective.
- 6.3. Whenever TBSLO repairs or replaces the Product at its expense or reimburses the purchase price, it shall reimburse the purchaser, with a credit note, the same surface freight amount the purchaser had when returning the Product to TBSLO.
- 6.4. Remedies pursuant to this article 6 shall constitute the sole and exclusive remedy in the event of a breach of warranty. For the avoidance of doubt, TBSLO shall not be liable for any incidental, consequential and/or non-pecuniary damages or damages having a comparable effect. TBSLO's aggregate liability in respect of any and all losses arising under or in connection to the contract/ purchase order/any similar document that is the basis for sale of Products, shall be limited to an amount equal to the invoiced price for the Products supplied. Any exclusions or limitations of liability are agreed to be extended for the benefit of all entities within TBSLO's group.

## 7. CLOSING PROVISIONS

- 7.1. No statement or action by Trelleborg Slovenija, whether express or implied, other than set forth herein, shall constitute a warranty.
- 7.2. Any applicability of general terms and conditions used by the purchaser, wherever stated, is hereby explicitly excluded, notwithstanding any provisions of such general terms and conditions to the contrary.
- 7.3. This warranty statement is subject to the laws of the Republic of Slovenia, with the exclusion of its conflict of law principles.





We are a division of Trelleborg Slovenija d.o.o.. We manufacture and sell rubber products for environmental protection and rescue operations and industrial use. Our growing division was established more than thirty years ago and is constantly striving to meet our customer's current and future needs and expectations.

**Knowledge and experience**

**Professional service**

**Quality products**

**A partner to rely on**

**KNOWLEDGE AND EXPERIENCE**

Thirty years of experience and knowledge, investment in new technology, team-work and working closely with our business partners, have enabled us to develop new and exciting products and to continuously improve our existing product range.

**QUALITY PRODUCTS**

When assessing quality of our products we carefully consider a number of criteria including environmental suitability, ease of use, design, safety, reliability, and packaging. Our production facilities are certified to the ISO 9001 and ISO 14001 standards.

**PROFESSIONAL SERVICE**

A professional but caring approach, flexibility and quick delivery times combined to provide the ideal service in support of our quality product range.

**A PARTNER TO RELY ON**

We understand the value of long-term partnership. Our aim is to develop trusting relationships, which foster success and bring benefits to both our partners and ourselves.

**QUALITY CERTIFICATES**

- ISO 9001
- ISO 14001
- OHSAS 18001
- GOST R 50982
- CNBOP-PIB







Trelleborg Slovenija, d.o.o.  
PG Environmental protection products (PG EKO)

We are a division of Trelleborg Slovenija d.o.o.. We manufacture and sell rubber products for environmental protection and rescue operations and industrial use. Our growing division was established more than thirty years ago and is constantly striving to meet our customer's current and future needs and expectations.

[WWW.TRELLEBORGSLOVENIJA.COM](http://WWW.TRELLEBORGSLOVENIJA.COM)  
[WWW.SAVATECH.COM](http://WWW.SAVATECH.COM)

Pneumatic pipe plugs | Pneumatic rehabilitation packers

Environmental protection products  
phone: +386 (0)4 206 6388  
e-mail: [tis.kra.info.eko@trelleborg.com](mailto:tis.kra.info.eko@trelleborg.com)  
fax: +386 (0)4 206 6390

Škofjeloška cesta 6, 4000 Kranj, Slovenia

